

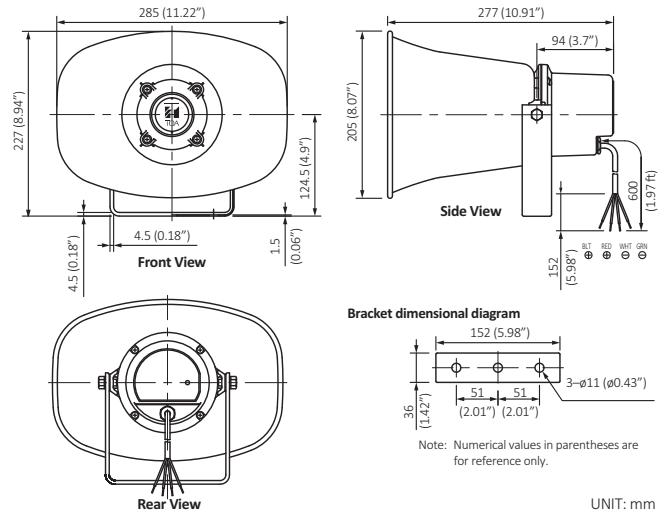

SC-630TU Paging Horn Speaker



APPEARANCE AND DIMENSIONAL DIAGRAM



DESCRIPTION

TOA SC-630TU Paging Horn Speaker is a high-impedance speaker featuring a built-in 25 V /70 V transformer with external screwdriver-adjustable power taps. With a rated input of 30W, it provides intelligible voice paging and tone signaling for indoor and outdoor sound system applications. The speaker is certified to UL 1480 UUMW (Mass Notification System) and ULC-S541 standards and is fully weather-resistant for reliable operation in demanding environmental conditions. It is easily installed in wall, pole or ceiling-mount applications. The SC-630TU is also designed for intercom talk-back applications, enabling dual operation as both a microphone and a speaker.

It features a double re-entrant horn with compression driver for high sensitivity and a lightweight aluminum enclosure. The loud-speaker diaphragm is heat- and moisture-resistant to prevent deformation and extend operation. The SC-630TU is also IP65 standards compliant for dust and moisture resistance with a wide operating temperature range from -40°F to 151° F (-40°C to 66° C).

* Note: For outdoor installation, it is recommended that they be installed under roofs, eaves, or in other locations not directly exposed to rain or snow.

FEATURES

- Paging horn speakers for voice paging and tone signaling distribution.
- Certified to Fire Alarm Signaling Speaker certification
- UL 1480 UUMW and ULC-S541 listed.
- Double re-entrant horn with compression driver
- High sensitivity: up to 113 dB (1 W/1 m)
- Usable as a microphone for intercom talk-back applications.
- Input impedance selector (25V and 70V) with rotary switch
- Controlled dispersion
- Weather-resistant to withstand demanding environmental conditions.
- IEC IP65 standards compliant for dust and moisture resistance.
- Non-flammable transformer case and speaker cable
- Extra wide temperature range: -40°F to 151°F
- Diaphragms employing special heat-resistant polyimide film to prevent the diaphragm from absorbing moisture and changing shape

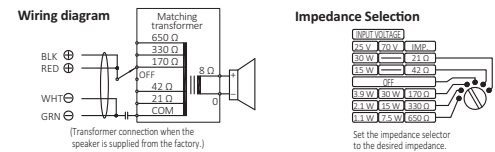

SPECIFICATIONS

Rated Input	30 W
Rated Impedance	70 V line: 170 Ω (30 W), 330 kΩ (15 W), 650 Ω (7.5 W) 25 V line: 21 Ω (30 W), 42 Ω (15 W), 170 Ω (3.9 W), 330 Ω (2.1W), 650 Ω (1.1 W)
Sound Pressure Level	113 dB (1 W, 1 m at 500 Hz to 2.5k Hz, peak level)
Frequency Response	250 Hz – 10k Hz
Dust/Water Protection	IP65
Polarity	Hot; Black and Red cables, Com: White and Green cables
UL Code	UL 1480 UUMW, ULC-S541
Operating Temperature	-40 °F to 151 °F (-40 °C to +66 °C)
Finish	Horn flare: Aluminum, white (RAL 9010 equivalent), powder coating / Reflector horn: ABS resin white (RAL 9010 equivalent) / Rear cover: ABS resin, gray (RAL 7031 equivalent) / Bracket, screws and bolts: Stainless steel
Dimensions (W x H x D)	11.22" x 8.94" x 10.91" (285 x 227 x 277 mm)
Weight	4.41 lbs. (2 kg)
Option	Swivel bracket: YS-151S (Can be used instead of the supplied bracket.)

Note: Avoid installing the speaker in locations which vibrate considerably, or under environments easy to be oil-contaminated.

Sound pressure level at 10 ft (3 m)

Voltage	70 Vrms			25 Vrms				
	30 W	15 W	7.5 W	30 W	15 W	3.9 W	2.1 W	1.1 W
Tap								
SPL per UL 1480 Reverberant Room (dBA)	105.3	103.7	100.8	105	103.6	99.2	96.5	93.5
SPL per ULC-S541 Anechoic Room (dBA)	111	109	107	100	91	89	87	85



SC-630TU Paging Horn Speaker



CHARACTERISTIC DIAGRAMS

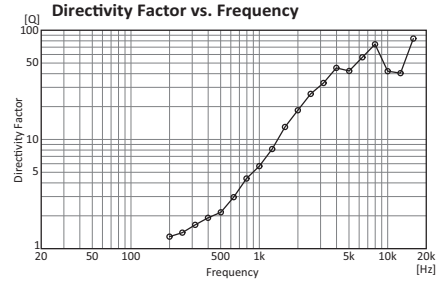
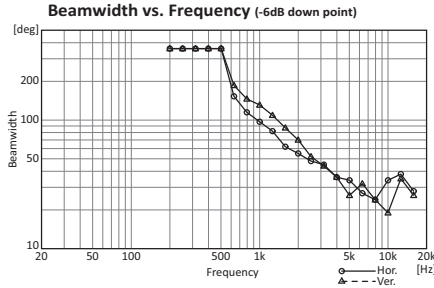
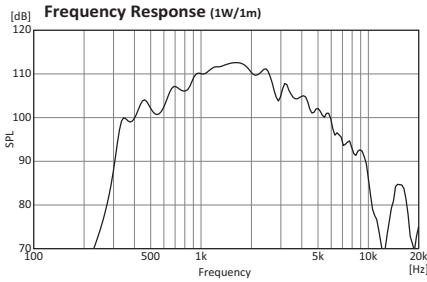

Polar Response

horizontal

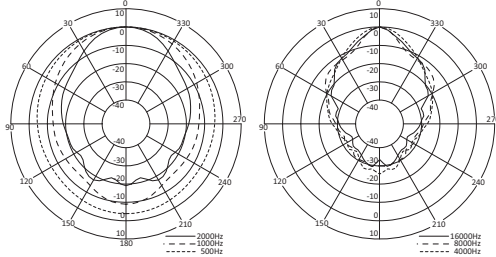

vertical

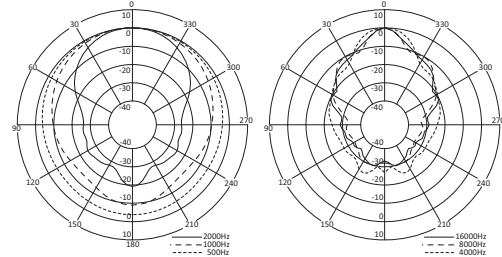

CHARACTERISTIC DIAGRAMS FPR USE AS MICROPHONE

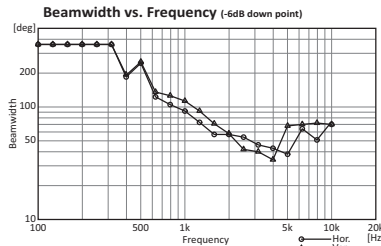
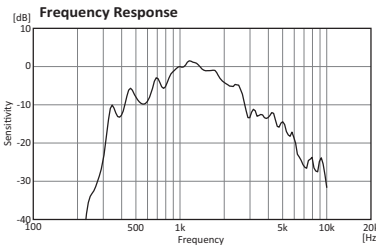

Polar Response

horizontal

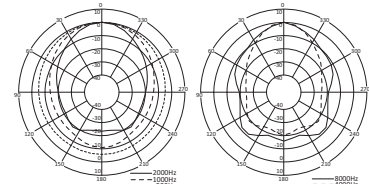

vertical

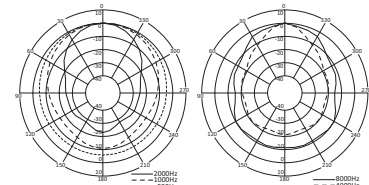

ARCHITECT'S & ENGINEER'S SPECIFICATIONS

TOA Paging Horn Speaker shall be a double re-entrant design suitable for paging and tone signaling distribution. The speaker component shall be a compression driver with a polyimide diaphragm to prevent deformation from heat and moisture. Power handling shall be 30W. The paging speaker shall include a matching transformer for connection to 25 V and 70 V speaker lines. Transformer wattage taps shall include 70 V: 30W (170 ohms), 15 W (330 ohms), 7.5 W (650 ohms); 25V: 30 W (21 ohms), 15 W (42 ohms) 3.9 W (170 ohms), 2.1 W (330 ohms), 1.1 W (650 ohms). Sound pressure level measured at one meter with one watt of power applied from 500 Hz to 2,500 Hz shall be 113 dB SPL. Frequency response shall be 250 Hz to 10 kHz. The paging horn shall comply with the IEC IP-65 standard for dust and moisture-resistance and operate within a temperature range from -40°F to 151°F (-40°C to 66°C). The material/finish shall be horn flare: aluminum, white, powder coating, reflector horn: ABS resin, white, rear

cover: ABS resin, gray. All mounting hardware, including screws and bolts, shall be stainless steel. The paging horn shall include a 4-core FPL listed speaker cable, insulated polyvinyl chloride type, with stair-relief 0.19" (4.8mm) diameter and 1.97 ft (600mm) length.

Dimensions shall be 11.22" (W) x 8.94" (H) x 10.91" (D) (285 x 227 x 277 mm). Weight shall be 4.42 lbs (2 kg).

The paging horn shall be certified to UL 1480 UUMW and ULC-S541 standards.

The paging horn shall be the TOA SC-630TU.

TOA Canada Corporation

Tel: 1-800-263-7639

Fax: 1-800-463-3569

sales@toacanada.com • www.TOAcana.com