



OPERATING INSTRUCTIONS

VOICE SECURITY SYSTEM

VS-900

Please follow the instructions in this manual to obtain the optimum results from this unit.
We also recommend that you keep this manual handy for future reference.

TOA Corporation

TABLE OF CONTENTS

BEFORE READING THIS MANUAL

1. INTRODUCTION	8
2. MANUAL CONTENTS	8
3. SYSTEM CONFIGURATION EXAMPLE	9

CHAPTER 1. SUBSTATION OPERATION

1. NOMENCLATURE

1.1. Indoor Substation RS-150	1-1
1.2. Indoor Vandal-Resistant Substation RS-160 and Outdoor Vandal-Resistant Substation RS-170	1-1
1.3. Emergency Substation RS-180	1-1
1.4. Outdoor Full-Duplex Substation RS-190 and Indoor Option Handset RS-191	1-2

2. SUBSTATION OPERATION

2.1. Calling	
2.1.1 Calling with the Call Button	1-3
2.1.2 Calling by Lifting the Handset (only when the RS-190 and RS-191 are combined)	1-4
2.2. Call Time-Out	1-5
2.3. Being Called	1-5
2.4. Conversation Method	1-6
2.5. Substation Priority Level	1-6

CHAPTER 2. BASIC OPERATION OF MASTER STATION

1. NOMENCLATURE AND FUNCTIONS	2-1
--	-----

2. MASTER STATION (TELEPHONE) OPERATION

2.1. Calling a Substation	2-2
2.2. Calling a Master station (Telephone)	2-3
2.3. Being Called	2-4
2.4. Conversation Method	2-5
2.5. Conversation Time-Out	2-6
2.6. Conversation Recording	2-6
2.7. Calling Party Display and Selective Response	
2.7.1 Calling party display	2-7
2.7.2 Selective response	2-8
2.8. Auto Dialing	
2.8.1 Auto dialing key call	2-9
2.8.2 Auto dialing key registration	2-9
2.8.3 Auto dialing key registration erasure	2-10
2.8.4 Auto dialing key registration confirmation	2-11

2.9. Redial	2-12
-------------------	------

CHAPTER 3. CONVENIENT FUNCTIONS
--

CALL-RELATED FUNCTIONS

1. GROUP CALL

1.1. Function	3-1
1.2. Group Call Operation	3-1

TRANSFER-RELATED FUNCTIONS

2. CALL TRANSFER

2.1. Function	3-3
2.2. Call Transfer Operation	
[Call hold]	3-3
[Transfer to the third party]	3-4
[Conversation restoration (Call back)]	3-5

CALL FORWARDING-RELATED FUNCTIONS

3. CALL FORWARDING

3.1. Function	3-6
3.2. Registration Operation	
3.2.1. Registration and cancellation at the original station	3-6
3.2.2. Registration and cancellation at the destination receiving station	3-6
3.3. Call Forwarding Operation	3-7

4. TIME-BASED CALL FORWARDING

4.1. Function	3-8
4.2. Registration and Cancellation	
4.2.1. Registration	3-8
4.2.2. Cancellation	3-8
4.3. Time-Based Call Forwarding Operation	3-9

5. NO-ANSWER CALL FORWARDING

5.1. Function	3-10
5.2. Registration and Cancellation	
5.2.1. Registration	3-10
5.2.2. Cancellation	3-10
5.3. No-Answer Call Forwarding Operation	3-11

6. BUSY CALL FORWARDING

6.1. Function	3-12
6.2. Registration and Cancellation	
6.2.1. Registration	3-12
6.2.2. Cancellation	3-12
6.3. Busy Call Forwarding Operation	3-12

MONITOR-RELATED FUNCTIONS

7. SCAN MONITOR

7.1. Function	3-13
7.2. Scan Monitor Operation	3-13

PAGING-RELATED FUNCTIONS

8. ZONE PAGING

- 8.1. Function 3-14
- 8.2. Zone Paging Dialing Operation 3-15

9. ALL-ZONE PAGING

- 9.1. Function 3-16
- 9.2. All-Zone Paging Dialing Operation 3-16

10. EMERGENCY PAGING

- 10.1. Function 3-17
- 10.2. Emergency Paging Dialing Operation 3-17

11. EXTERNAL SOURCE DISTRIBUTION

- 11.1. Function 3-18
- 11.2. External Source Distribution Operation 3-18

12. PAGING TIME-OUT

3-18

13. PAGING REDIAL

- 13.1. Function 3-19
- 13.2. Paging Redialing Operation 3-19

TELEPHONE-RELATED FUNCTIONS

14. OUTGOING TELEPHONE CALLS

- 14.1. Outside Line Dialing Operation 3-19

15. INCOMING OUTSIDE LINE CALLS (DIRECT-IN LINE)

- 15.1. Direct-In Line Function 3-20
- 15.2. Incoming Outside Line Call Operation 3-20

16. INCOMING OUTSIDE LINE CALLS (DIRECT-IN DIALING)

- 16.1. Direct-In Dialing Function 3-21
- 16.2. Incoming Outside Line Call Operation 3-21

17. OUTSIDE LINE CONNECTION TIME-OUT

3-22

18. OUTSIDE LINE CONVERSATION RECORDING

3-22

19. OUTSIDE LINE CALL FORWARDING

- 19.1. Function 3-22
- 19.2. Registration and Cancellation
 - 19.2.1. Registration 3-22
 - 19.2.2. Cancellation 3-23
- 19.3. Outside Line Call Forwarding Operation 3-23

20. TIME-BASED OUTSIDE LINE CALL FORWARDING

- 20.1. Function 3-24
- 20.2. Registration and Cancellation
 - 20.2.1. Registration 3-24
 - 20.2.2. Cancellation 3-24
- 20.3. Time-Based Outside Line Call Forwarding Operation 3-25

21. OUTSIDE LINE NO-ANSWER CALL FORWARDING	
21.1. Function	3-26
21.2. Registration and Cancellation	
21.2.1. Registration	3-26
21.2.2. Cancellation	3-26
21.3. Outside Line No-Answer Call Forwarding Operation	3-27

22. OUTSIDE LINE BUSY CALL FORWARDING	
22.1. Function	3-28
22.2. Registration and Cancellation	
22.2.1. Registration	3-28
22.2.2. Cancellation	3-28
22.3. Outside Line Busy Call Forwarding Operation	3-28

CONFERENCE-RELATED FUNCTIONS

23. THREE-PARTY CONFERENCE (INDIVIDUAL CALL CONFERENCE)	
23.1. Function	3-29
23.2. Three-Party Conference Dialing Operation	
23.2.1. Initiating a 3-party conference	3-29
23.2.2. Initiating a 3-party conference during a 2-party conversation	3-31
23.2.3. Operation details of 3-party conference	3-32

24. EMERGENCY CONFERENCE	
24.1. Function	3-33
24.2. Emergency Conference Dialing Operation	3-33

CHAPTER 4. SUMMARY OF DIALING OPERATIONS AND PRIORITIES

1. MASTER STATION OPERATION TABLE	4-1
2. PRIORITIES	
2.1. Call Priority	
2.1.1. Call Priority and call tone (Calls to master stations)	4-2
2.1.2. Call Priority (Calls to telephones)	4-2
2.1.3. Calls to substations	4-2
2.2. Speech Path Priority	4-3

CHAPTER 5. PC-CONTROLLED FUNCTIONS

1. THE ROLES OF PC INTERFACE SOFTWARE	5-1
2. SYSTEM PROGRAMMING (DATA SETTING)	
2.1. System Setting	5-1
2.2. Line Setting	5-1
2.3. Function Setting	5-3
3. MAINTENANCE/CONTROL FUNCTIONS	5-5
4. VS-900DI SETTING	5-5

FCC REQUIREMENTS

- (1) This equipment complies with Part 68 of the FCC rules. On the front panel of this equipment is a label that contains, among other information, the FCC registration number and ringer equivalence number (REN) for this equipment. If requested, this information must be provided to the telephone company.
- (2) USOC Jack RJ11C or RJ11W
- (3) This Equipment is designed to be connected to the telephone network or premises wiring using a compatible modular jack that is Part 68 compliant. See this manual (VS-900 INSTALLATION MANUAL) for details.
- (4) The REN is used to determine the quantity of devices that may be connected to the telephone line. Excessive REN's on the telephone line may result in the devices not ringing in response to an incoming call. Typically, the sum of REN's should not exceed five (5.0). To be certain of the number of devices that may be connected to a line (as determined by the total REN's), contact the local telephone company.
- (5) If this equipment VS-900 causes harm to the telephone network, the telephone company will notify you in advance that temporary discontinuance of service may be required. But if advance notice isn't practical, the telephone company will notify the customer as soon as possible. Also, you will be advised of your right to file a complaint with the FCC if you believe it is a necessary.
- (6) The telephone company may make changes in its facilities, equipment, operations, or procedures that could affect the operation of the equipment. If this happens, the telephone company will provide advance notice in order for you to make the necessary modifications in order to maintain uninterrupted service.
- (7) If trouble is experienced with this equipment VS-900, please contact TOA Electronics, Inc., 601 Gateway Boulevard, Suite 300, South San Francisco, CA. 94080, phone (650) 588-2538 for repair and warranty information. If the trouble is causing harm to the telephone network, the telephone company may request you remove the equipment from the network until the problem is resolved.
- (8) This equipment may not be used on coin service provided by the telephone company. Connection to party lines is subject to state tariffs.
- (9) This equipment is hearing aid compatible.

WARNING (For U.S.A. only)

This equipment generates, uses, and can radiate radio frequency energy and, if not installed and used in accordance with the instructions manual, may cause interference to radio communications. It has been tested and found to comply with the limits for a Class A computing device pursuant to Subject J of Part 15 of the FCC Rules, which are designed to provide reasonable protection such interference when operated in a commercial environment.

Operation of this equipment in a residential area is likely to cause interference, in which case the user at his own expense will be required to take whatever measures may be required to correct the interference.

INDUSTRIAL CANADA REQUIREMENTS

EQUIPMENT ATTACHMENT LIMITATIONS

"NOTICE: The Industry Canada label identifies certified equipment. This certification means that the equipment meets telecommunications network protective, operational and safety requirements as prescribed in the appropriate Terminal Equipment Technical Requirements document(s). The Department does not guarantee the equipment will operate to the user's satisfaction.

Before installing this equipment, users should ensure that it is permissible to be connected to the facilities of the local telecommunications company. The equipment must also be installed using an acceptable method of connection. The customer should be aware that compliance with the above conditions may not prevent degradation of service in some situations.

Repairs to certified equipment should be coordinated by a representative designated by the supplier. Any repairs or alterations made by the user to this equipment, or equipment malfunctions, may give the telecommunications company cause to request the user to disconnect the equipment.

Users should ensure for their own protection that the electrical ground connections of the power utility, telephone lines and internal metallic water pipe system, if present, are connected together. This precaution may be particularly important in rural areas.

Caution: Users should not attempt to make such connections themselves, but should contact the appropriate electric inspection authority, or electrician, as appropriate."

"NOTICE: The **Ringer Equivalence Number** (0.4) assigned to each terminal device provides an indication of the maximum number of terminals allowed to be connected to a telephone interface. The termination on an interface may consist of any combination of devices subject only to the requirement that the sum of the Ringer Equivalence Numbers of all the devices does not exceed 5."

RESTRICTIONS CONCERNANT LE RACCORDEMENT DE MATÉRIEL

"AVIS: L'étiquette d'Industrie Canada identifie le matériel homologué. Cette étiquette certifie que le matériel est conforme aux normes de protection, d'exploitation et de sécurité des réseaux de télécommunications, comme le prescrivent les documents concernant les exigences techniques relatives au matériel terminal. Le Ministère n'assure toutefois pas que le matériel fonctionnera à la satisfaction de l'utilisateur.

Avant d'installer ce matériel, l'utilisateur doit s'assurer qu'il est permis de le raccorder aux installations de l'entreprise locale de télécommunication. Le matériel doit également être installé en suivant une méthode acceptée de raccordement. L'abonné ne doit pas oublier qu'il est possible que la conformité aux conditions énoncées ci-dessus n'empêche pas la dégradation du service dans certaines situations.

Les réparations de matériel homologué doivent être coordonnées par un représentant désigné par le fournisseur. L'entreprise de télécommunications peut demander à l'utilisateur de débrancher un appareil à la suite de réparations ou de modifications effectuées par l'utilisateur ou à cause de mauvais fonctionnement.

Pour sa propre protection, l'utilisateur doit s'assurer que tous les fils de mise à la terre de la source d'énergie électrique, des lignes téléphoniques et des canalisations d'eau métalliques, s'il y en a, sont raccordés ensemble. Cette précaution est particulièrement importante dans les régions rurales.

Avertissement: L'utilisateur ne doit pas tenter de faire ces raccordements lui-même; il doit avoir recours à un service d'inspection des installations électriques, ou à un électricien, selon le cas."

"AVIS: L'indice d'équivalence de la sonnerie (0.4) assigné à chaque dispositif terminal indique le nombre maximal de terminaux qui peuvent être raccordés à une interface. La terminaison d'une interface téléphonique peut consister en une combinaison de quelques dispositifs, à la seule condition que la somme d'indices d'équivalence de la sonnerie de tous les dispositifs n'excède pas 5."

This Class A digital apparatus complies with Canadian ICES-003.

Cet appareil numérique de la classe A est conforme à la norme NMB-003 du Canada.

BEFORE READING THIS MANUAL

1. INTRODUCTION

This manual explains all of the station functions and operations of the TOA Voice Security System. This includes functions that can only be performed by certain types of stations. In the Voice Security System, a personal computer can be used to conveniently and efficiently set function parameters and other detailed specifications (such as station number assignment or digit length or name registration) depending on system configuration (referred to as "system programming"). Note that dialing operations or displayed contents shown in this manual are only examples of the above-mentioned settings.

2. MANUAL CONTENTS

This manual is divided into the following 5 chapters.

CHAPTER 1. SUBSTATION OPERATION

Be sure to read this chapter.

CHAPTER 2. BASIC OPERATION OF MASTER STATION

Be sure to read this chapter when using the master station.

CHAPTER 3. CONVENIENT FUNCTIONS

Making the most of convenient functions described in this chapter allows smoother and more efficient communications.

CHAPTER 4. SUMMARY OF DIALING OPERATIONS AND PRIORITIES

All of the functions and operations described in the previous chapters are summarized for quick reference.

CHAPTER 5. PC-CONTROLLED FUNCTIONS

This chapter explains the functions which can be performed or modified by the system operator. Shown herein are system programming, remote dialing, control, system monitoring, maintenance and other functions that can be performed using a PC software.

For detailed operations, refer to the separate "VS-900 SETUP SOFTWARE MANUAL."

3. SYSTEM CONFIGURATION EXAMPLE

The figure below shows the system configuration and main system equipment described in this manual.

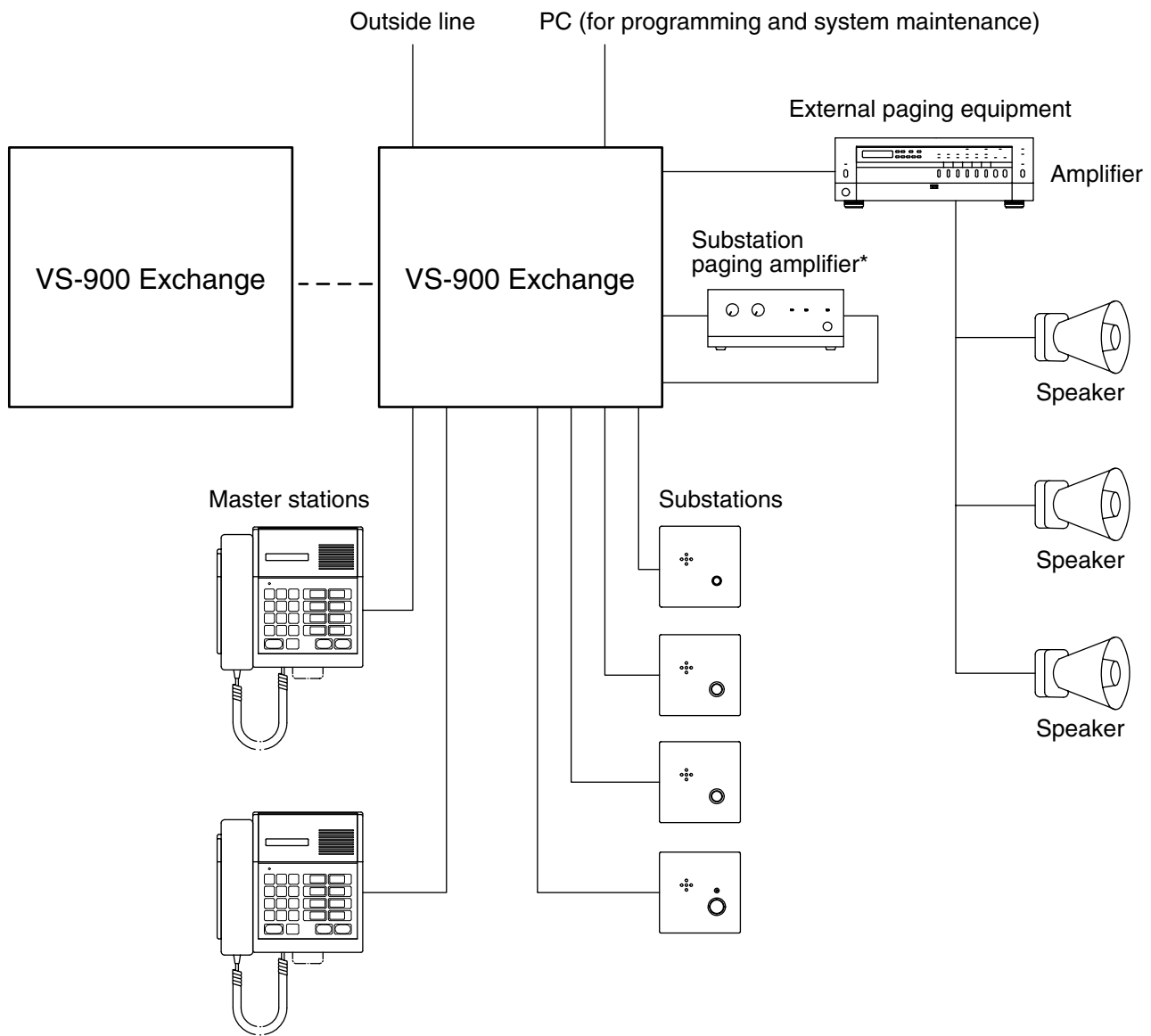

* Substation paging needs an external amplifier (ex. BG-130).

CHAPTER 1. SUBSTATION OPERATION

1. NOMENCLATURE

1.1. Indoor Substation RS-150

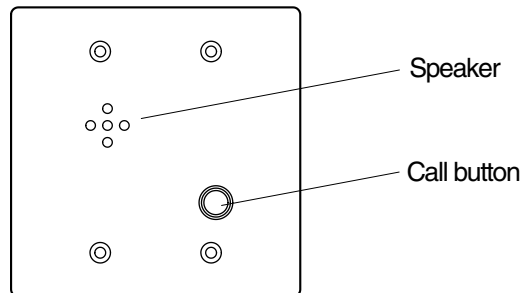

1.2. Indoor Vandal-Resistant Substation RS-160 and Outdoor Vandal-Resistant Substation RS-170

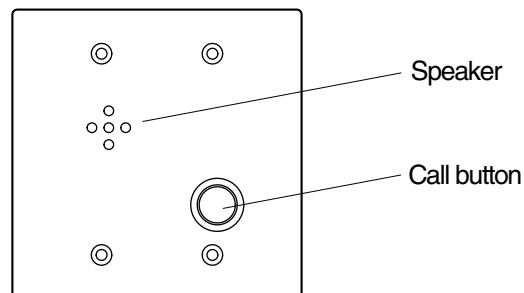

1.3. Emergency Substation RS-180

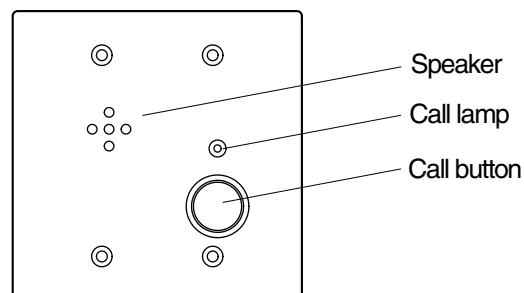

1.4. Outdoor Full-Duplex Substation RS-190 and Indoor Option Handset RS-191

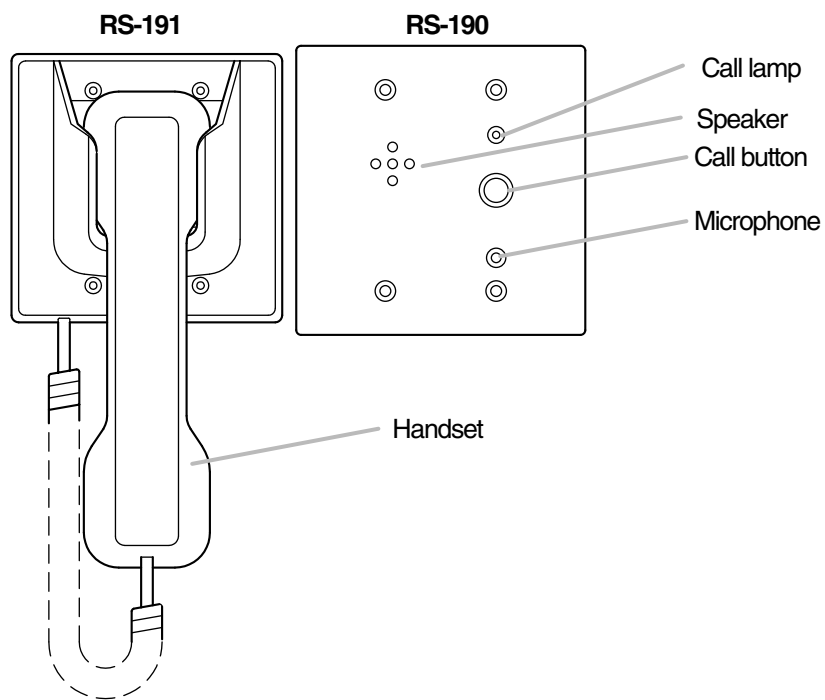

2. SUBSTATION OPERATION

2.1. Calling

2.1.1. Calling with the Call Button

- Step 1.** Press the call button on the panel.
 → Calls the designated master station.
 The call lamp flashes (RS-180 and RS-190 only).

[System pre-programming]

The master station corresponding to each substation must be registered by system programming at the time of installation.

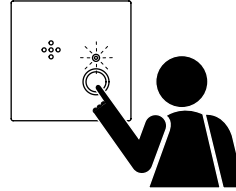

- Step 2.** If the master station responds, a brief call tone is sounded.
 The call lamp mode changes from flashing to steady-on state (RS-180 and RS-190 only).
 → Speak toward the panel.

Note

Lifting the handset permits handset conversation when the RS-191 is combined with the RS-190.

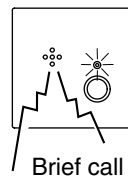

Brief call tone

then

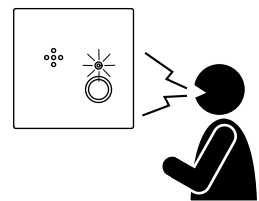

- Step 3.** If the master station replaces the handset or presses the [C] key, the conversation is terminated.
 → The call lamp is extinguished (RS-180 and RS-190 only).

Note

Replacing the handset terminates the conversation when the RS-191 is combined with the RS-190.

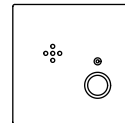

2.1.2. Calling by Lifting the Handset (only when the RS-190 and RS-191 are combined)

Step 1. Lift the handset.

- Calls the designated master station.
The RS-190's call lamp flashes.

[System pre-programming]

The master station corresponding to the substation must be registered by system programming at the time of installation.

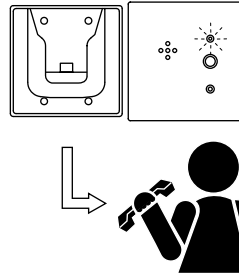

Step 2. If the master station responds, a brief call tone is sounded through the handset speaker. The call lamp mode changes from flashing to steady-on state.

- Speak into the handset.

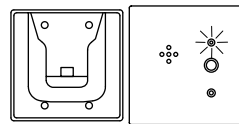

Brief call tone

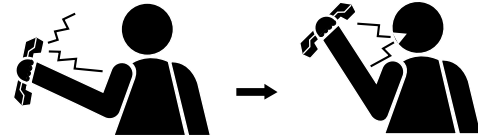

Step 3. If the handset replaces or the master station replaces the handset or presses the [C] key, the conversation is terminated.

- The call lamp is extinguished.

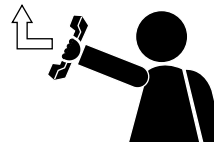
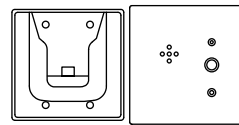

2.2. Call Time-Out

Calls from the substation can be automatically terminated when the specified time is reached if no response is made.

[System pre-programming]

- Program whether to [Enable] or [Disable] the Call Time-Out function.
- Set a call time limit of 1-99 minutes in 1 minute units

Note

The Call Time-Out function cannot be used for calls from the emergency substation.

2.3. Being Called

- Step 1.** Following a brief call tone, the calling party's voice is heard.
The call lamp lights (RS-180 and RS-190 only).

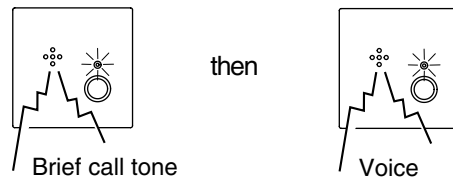

- Step 2.** Speak toward the panel.

Note

Lifting the handset permits handset conversation when the RS-191 is combined with the RS-190.

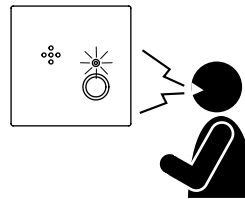

- Step 3.** If the master station replaces the handset or presses the [C] key, the conversation is terminated.
→ The call lamp is extinguished (RS-180 and RS-190 only).

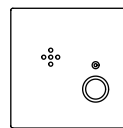

2.4. Conversation Method

[RS-150, RS-160, RS-170, and RS-180]

- The other party's voice is heard from the speaker.
- Your voice is not sent out while the other party is talking.
- Speak after the other party finishes talking.
- While the other party is not talking, the substation speaker will function as a microphone to convey your voice. [This method of communication is referred to as a "Talk-Back method."]

[RS-190]

Conversation method differs depending on the other party's conditions as stated below.

- When communicating with a master station with the handset on-hook or an outside line telephone, the Talk-Back method is used.
- When communicating with a master station with the handset off, the handsfree simultaneous conversation method is used.

[RS-191]

- Similar to an ordinary telephone, the handset simultaneous conversation method is used.

2.5. Substation Priority Level

Any substation can be registered as an "Emergency substation" by system programming at the time of installation. The Emergency substation is given priority when calling the master station (telephone).

CHAPTER 2. BASIC OPERATION OF MASTER STATION

This Voice Security System permits commercial telephones to be used instead of dedicated master stations. However, note that some functions cannot be performed by the telephone.

1. NOMENCLATURE AND FUNCTIONS

[Front]

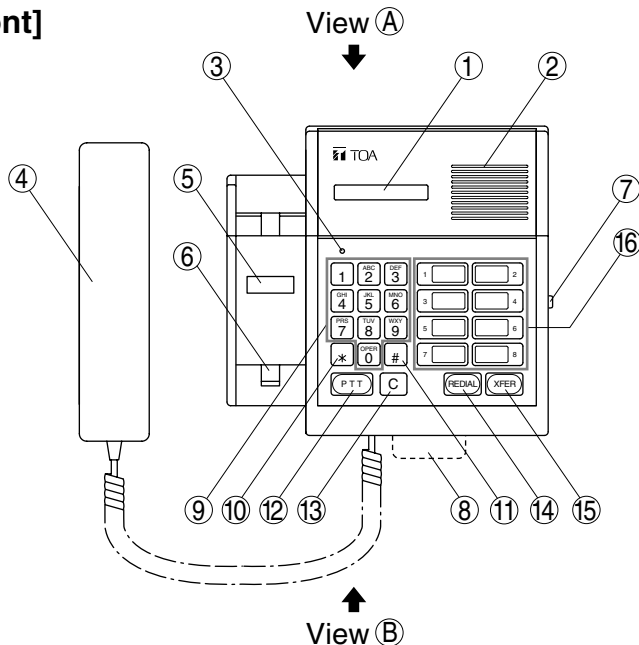

[View A]

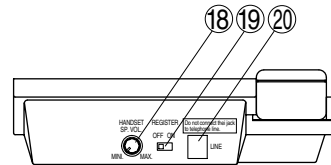

[View B]

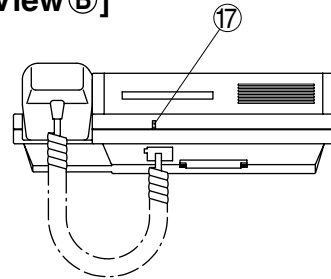

- 1. Display panel**
Shows connection status and registered data.
- 2. Internal speaker**
Sounds call tones and permits "handsfree" conversation.
- 3. In-use lamp**
Lights when station is busy.
- 4. Handset**
Lift the handset or press the [PTT] key to respond to a call.
- 5. Station number card**
Write the station's number in this card.
- 6. Hook switch**
- 7. Speaker volume selector switch [SP.VOL H/L]**
Adjusts the internal speaker's volume level.
- 8. Station number directory**
- 9. Numeric dialing keys [0] – [9]**
Used for dialing
- 10. [*] key**
Used for registration and dialing operations of call paging functions or other special functions.
- 11. [#] key**
Used for registration and dialing operations of special functions.
- 12. Press-to-talk [PTT] key**
Used for speaking in press-to-talk conversation mode. Functions as a Response key to answer incoming calls.
- 13. Cancel [C] key**
Terminates calls.
- 14. [REDIAL] key**
Automatically redials the last dialed number. Also, functions as a station select key to cycle the display through waiting calls.
- 15. Transfer [XFER] key**
Used to transfer calls. First press this key, then dial the station number to which calls are transferred.
- 16. Auto dialing keys [1] – [8]**
Automatically dial the registered station number.
- 17. Internal microphone**
Used in "handsfree" operation.
- 18. Handset speaker volume [HANDSET SP. VOL.]**
Adjusts the handset speaker's volume level.
- 19. Registration ON/OFF switch [REGISTER ON/OFF]**
Set this switch to ON when registering auto dialing information or other data into the station. Normally, set this switch to OFF.
- 20. Line connector [LINE]**
Connects the line to the exchange.

2. MASTER STATION (TELEPHONE) OPERATION

2.1. Calling a Substation

Step 1. Dial the desired substation number. (Dialing can be performed with the handset on-hook or off-hook.)

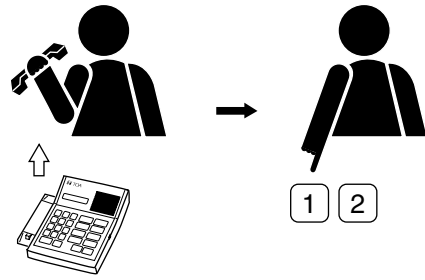

Step 2. Following a brief call tone, the master station is automatically connected to the substation. The master station's voice is heard at the substation while the master station operator is talking, and the substation's voice is only heard at the master station when the master station operator stops talking.

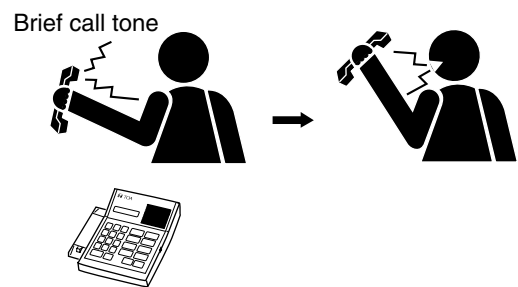

Step 3. To terminate the conversation, replace the handset or press the [C] key.

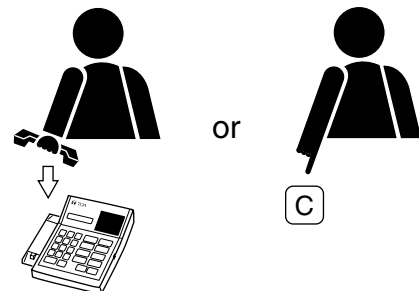

2.2. Calling a Master Station (Telephone)

Step 1. Dial the desired station number. (Dialing can be performed with the handset on-hook or off-hook.)

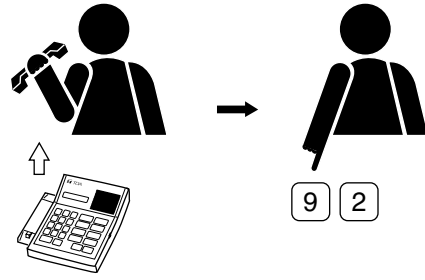

Step 2. A trill call tone is heard at the calling station handset. (This tone will be heard from the station's internal speaker if dialed with the handset on-hook.)



Step 3. The call tone stops and conversation can proceed when the called party answers.



Step 4. To terminate the conversation, replace the handset or press the [C] key.

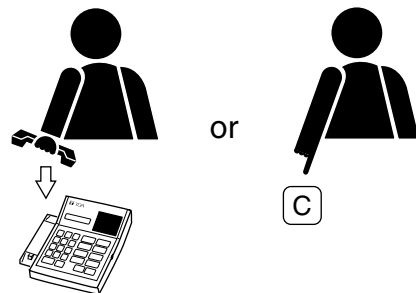

2.3. Being Called

Step 1. A trill call tone is heard.



Step 2. Lifting the handset stops the call tone and permits conversation to proceed. (A response can also be made by pressing the [PTT] key for handsfree conversation.)

[Response with the [PTT] key]

- (1) Simultaneous conversation is possible if the calling party is speaking with the master station handset lifted.
- (2) "Press-to-talk" alternate conversation is possible if the calling party is speaking with the master station handset on-hook.

Refer to "2.4. Conversation Method."

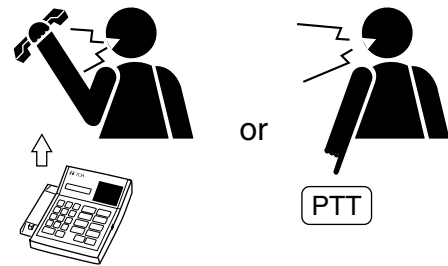

Step 3. To terminate the conversation, replace the handset or press the [C] key.

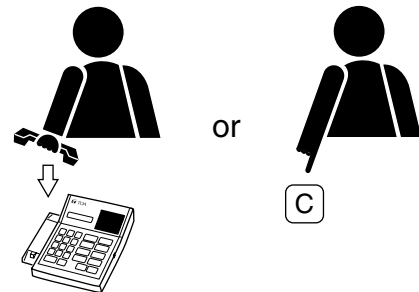

2.4. Conversation Method

There are three different conversation methods possible when the master station is used. The conversation method is determined by the other party's station type and handset use.

(1) **Voice-operated switching conversation** ("VOX" in the table below)

When both parties are talking coincidentally, the master station's (telephone's) party voice is transmitted to the substation. If the master station's party stops talking, the substation's party voice can be heard at the master station.

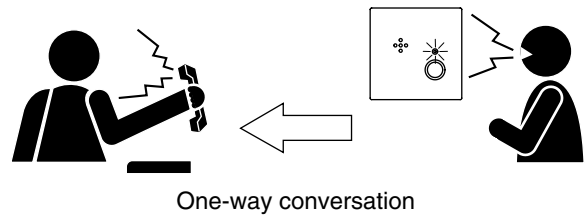
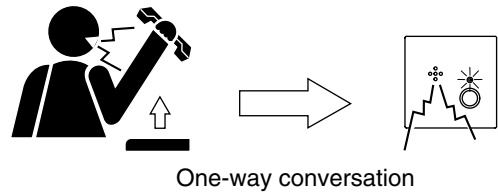

(2) **"Press-to-talk" control conversation** ("PTT" in the table below)

The [PTT] key is pressed to talk, and released to listen.

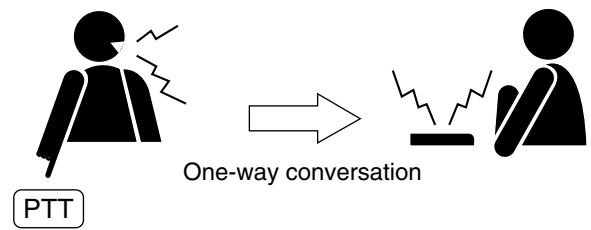

(3) **Duplex conversation**

Similar to the method of a standard telephone.

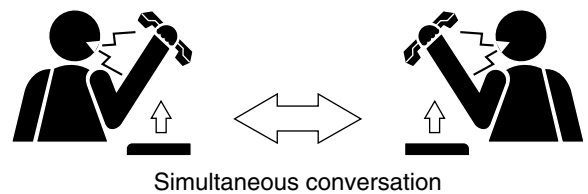

The following table shows the conversation modes for all of the various station combinations.

Quick reference of conversation methods

		Substation	Master Station		Telephone
			Off-hook	On-hook	
Substation	RS-150/-160/-170/-180	—	VOX/PTT	PTT	VOX
	RS-190	—	Duplex	PTT	VOX
	RS-191	—	Duplex	Duplex	Duplex
Master station	Handset off-hook	/	Duplex	Duplex	Duplex
	Handset on-hook	/	/	PTT	VOX
Telephone		/	/	/	Duplex

VOX: Voice-operated switching conversation

PTT: "Press-to-talk" control conversation

Duplex: Simultaneous conversation

2.5. Conversation Time-Out

- Conversation time can be limited to automatically terminate conversations.
- When the limited time is reached, a warning signal tone is transmitted to both the calling and called parties to terminate the conversation.

[System pre-programming]

- Program whether to [Enable] or [Disable] the Conversation Time-Out function.
- Set a conversation time limit of 10-990 seconds in 10-second units.

Note

The Conversation Time-Out function cannot be used for

- Emergency conference
- Outside line telephone conversation
- Response to emergency calls

2.6. Conversation Recording

Connecting an external recording device permits independent recording of conversation of each master station or telephone.

Note

The external control output is made when the master station's (or telephone's) conversation is started, and is broken when the conversation is finished. (For equipment connections and operations, refer to the "VS-900 INSTALLATION MANUAL.")

2.7. Calling Party Display and Selective Response

2.7.1. Calling party display

The master station can only display one of up to 64 calling stations by means of its 6-digit number or 8-character name. When the master station simultaneously receives calls from two or more stations, the station with the highest priority is displayed, and other waiting stations are displayed in order of priority as the [REDIAL] key is pressed. (Substation priorities are registered by system programming.)

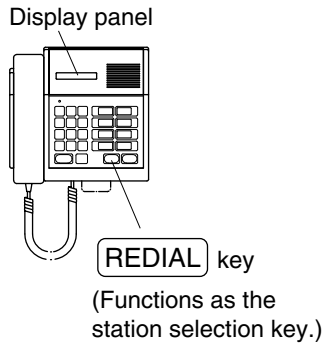

Example of calling station indication

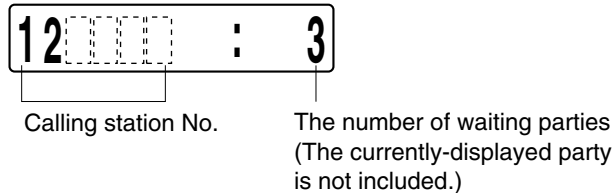

Example of selected calling station indication

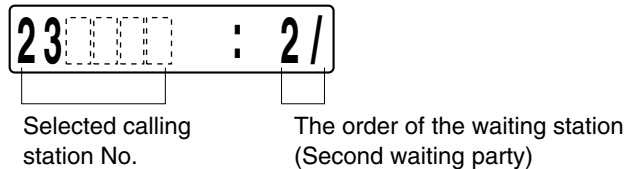

Note

For telephones, only the first calling station (telephone) number can be displayed. Soon after the conversation with the station is terminated, the call comes from the next waiting station in priority order and its station number is displayed. (This feature is available with "Caller ID" compatible telephones only.*)

* Depending on the type of telephone (and its display), even when the telephone simultaneously receives multiple calls, the number indication may not change, displaying the number different from that of an actual conversation partner.

[Calls are displayed in the following order of priority]

1. Emergency conference calls
2. Emergency substation calls
3. Incoming outside line calls
4. Normal substation calls
5. Master station or a telephone calls

2.7.2. Selective response

When multiple calls are simultaneously made to the master station, the master station can select and answer any desired calling party. (Note this function can only be performed by a dedicated master station and not a telephone.)

[Operation]

Step 1. Press the [REDIAL] key, and the station number or name of the second calling party will be displayed. (Subsequent depressions of the [REDIAL] key cycle the display through all waiting station numbers or names.)

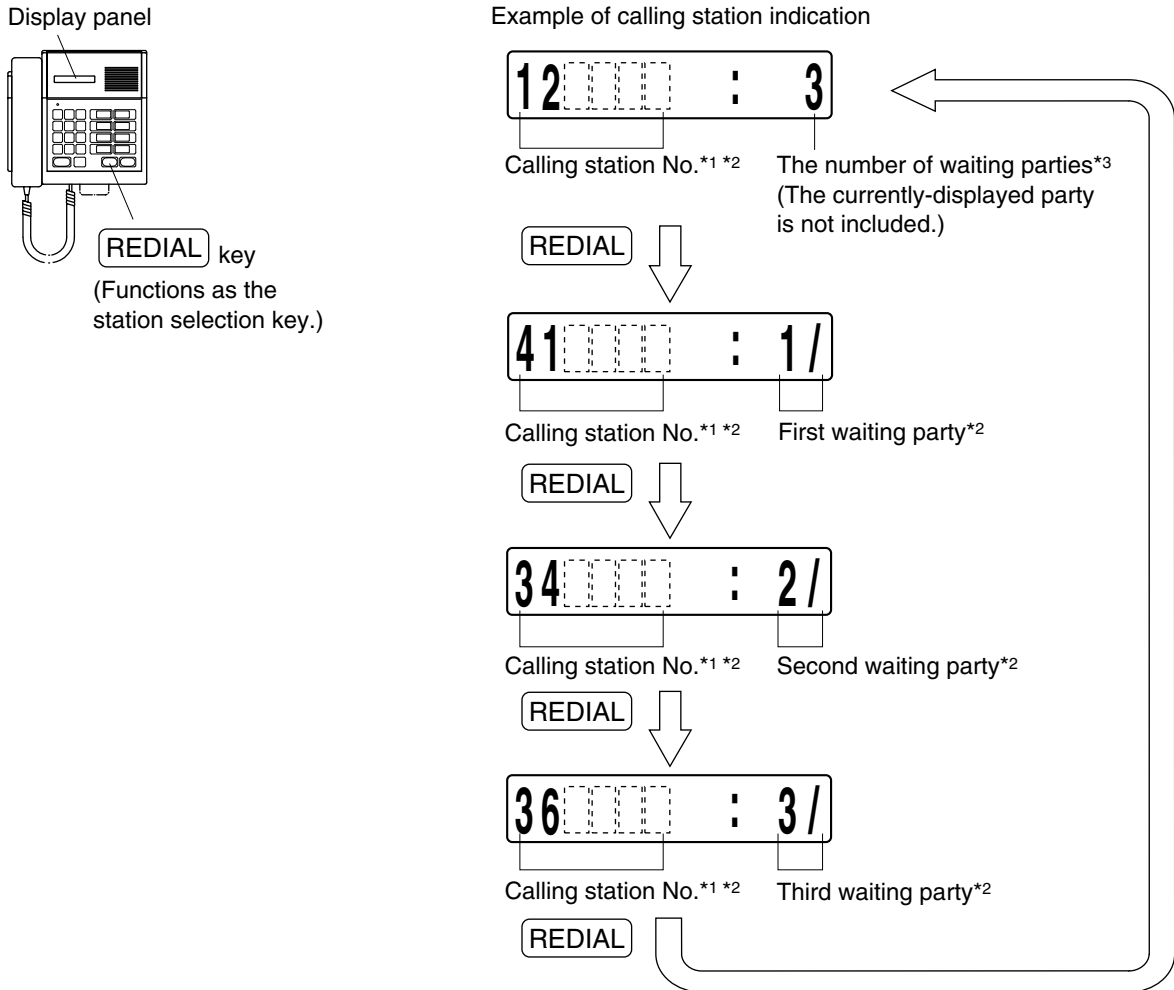

*1 The name of the calling party may be displayed. Example: Store
 *2 Flashes when the call is made from a Emergency substation.
 *3 Flashes when the Emergency substation is included.

Step 2. Lift the handset when the desired station number (name) is displayed. The call tone then stops and conversation can begin. (The [PTT] key may also be pressed for handsfree response.)

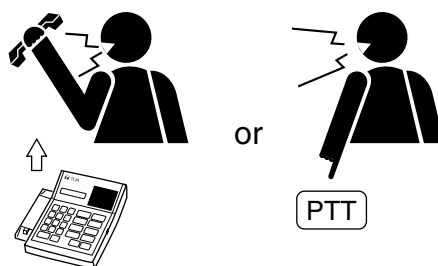

2.8. Auto Dialing

2.8.1. Auto dialing key call

A one-touch press of an auto dialing key automatically dials the station number or functional number of dialing sequence to activate Paging, Call Forwarding, or other functions assigned to into that key. There are 8 auto dialing keys [1] – [8].

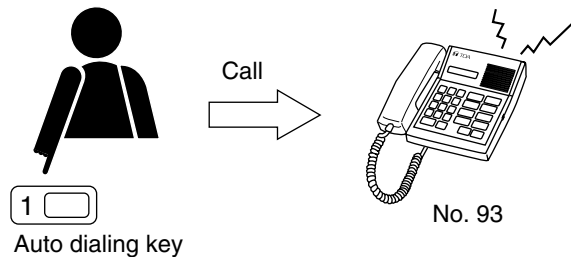

2.8.2. Auto dialing key registration

Step 1. Set the [REGISTER] switch on the master station's top panel to the ON position. The display panel will be placed in registration mode.

Reg_mode

Step 2. Press the [PTT] key.
The following characters will be displayed.

Auto dial

Step 3. Press the auto dialing key to register.
The selected key number (example: [2]) will be displayed.

2: Example of auto dialing key [2]

If a station number or functional number has already been assigned to the auto dialing key, the assigned station number will also be displayed following the auto dialing key number (example: [2]).

2:900000 Example of auto dialing key [2] already assigned

Step 4. Press the [PTT] key.

2: Example of auto dialing key [2]

The number, if previously assigned and displayed, will be erased.

Step 5. Press the new keys to register using the dialing keys [0] – [9] or function keys [*], [#] or [REDIAL].

2:123456

Example of "123456" being entered

Notes

- If the [C] key is pressed before dialing a complete number, the contents before the [C] key was pressed are all erased.
- Mark "-" is displayed when the [REDIAL] key is pressed.
- The display shown below is an example of entering the functional number of paging.

2:*80#

Step 6. Press the [PTT] key after completing the entry of the registration number. Registration is then completed, as indicated by a confirmation tone.

2:123456

Example showing the registration completion of "123456"

Step 7. Shift the [REGISTER] switch back to the OFF position. The station will be placed in standby mode.

11:59am

2.8.3. Auto dialing key registration erasure

Step 1. Set the [REGISTER] switch on the master station's top panel to the ON position. The display panel will be placed in registration mode.

Reg_mode

Step 2. Press the [PTT] key. The following characters will be displayed.

Auto dial

Step 3. Press the registered auto dialing key to delete. The selected key number (example: [2]) will be displayed together with the registered number.

2:123456

Example showing "123456" has been registered

Step 4. Press the [PTT] key. The registered number displayed after the auto dialing key [2] will be erased.

2:

Example of auto dialing key [2]

Step 5. Press the [PTT] key again.

The erasure is then completed, as indicated by a confirmation tone.

2:

Example of auto dialing key [2]

Step 6. Shift the [REGISTER] switch back to the OFF position. The station will be placed in standby mode.

11:59am

2.8.4. Auto dialing key registration confirmation

Step 1. Set the [REGISTER] switch on the master station's top panel to the ON position. The display panel will be placed in registration mode.

Reg_mode

Step 2. Press the [PTT] key.

The following characters will be displayed.

Auto dial

Step 3. Press the registered Auto dialing key to be confirmed. The selected key number (example: [2]) will be displayed together with the registered number.

2:123456

Example showing auto dialing key [2] registration display

If the registered number being displayed exceeds the available display screen, pressing the [#] key advances the display to the next digit screen, and pressing the [*] key returns the display to the previous digit screen.

Step 4. Shift the [REGISTER] switch back to the OFF position. The station will be placed in standby mode.

11:59am

2.9. Redial

By one-touch pressing the master station's [REDIAL] key, the last dialed number will be dialed again.

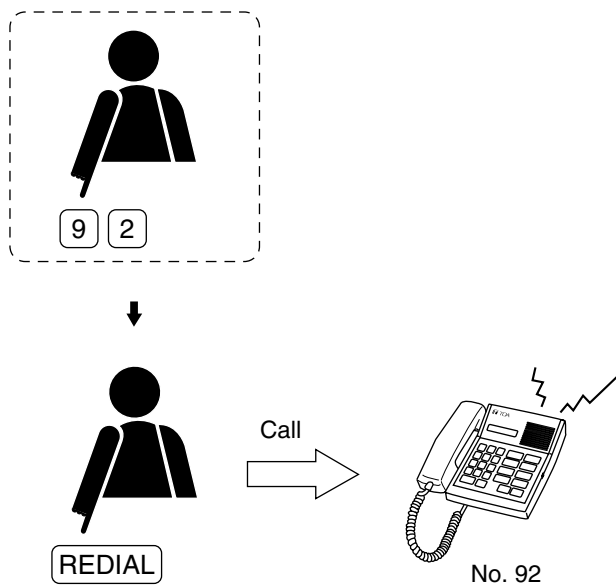

CHAPTER 3. CONVENIENT FUNCTIONS

CALL-RELATED FUNCTIONS

1. GROUP CALL

1.1. Function

A designated group of up to 16 master stations or telephones can be called from any substation, which is answered from any called master station (telephone).

[System pre-programming]

First, one of master stations (telephones) in a group must be programmed as a representative station, and the rest as member stations. Then, a calling substation must be programmed to call the representative station.

1.2. Group Call Operation

Step 1. Making a call from the substation simultaneously sounds a call tone at all master stations (telephones) in the designated group.

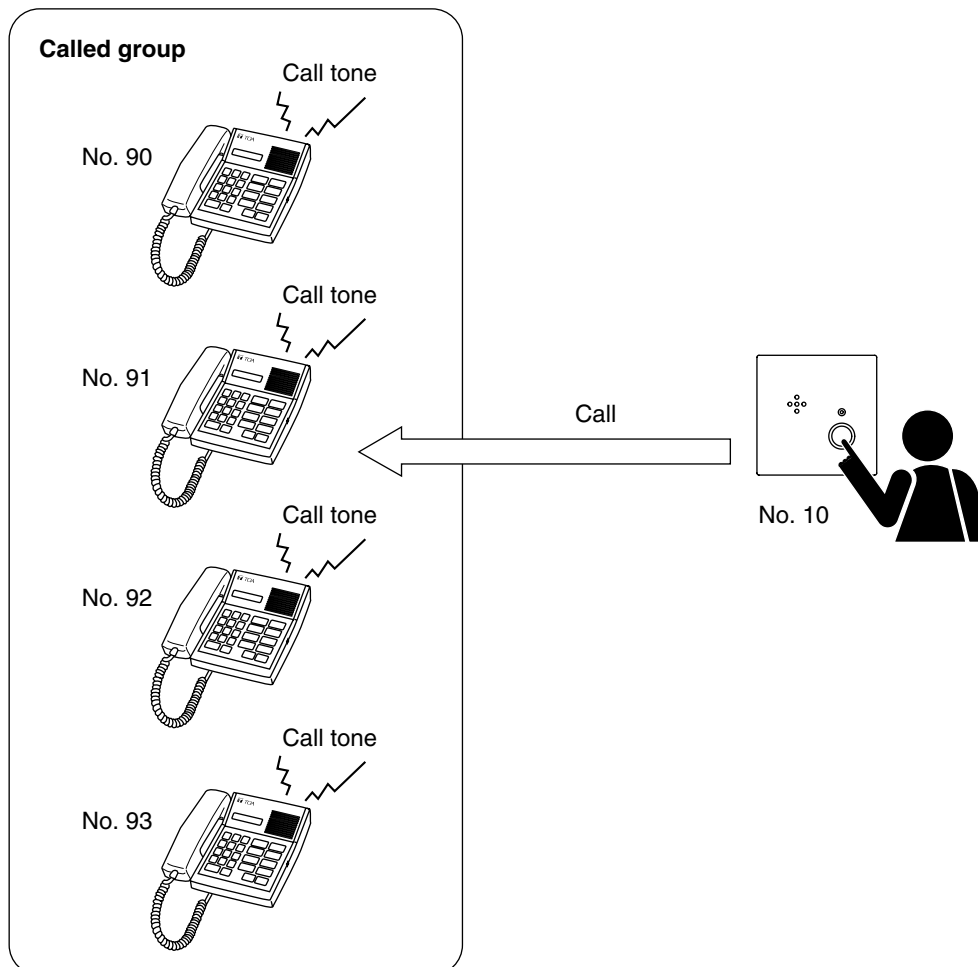

Step 2. When one of the called master stations (telephones) lifts the handset or presses the [PTT] key, that station (telephone) is connected to the substation, cancelling the call to the other stations.

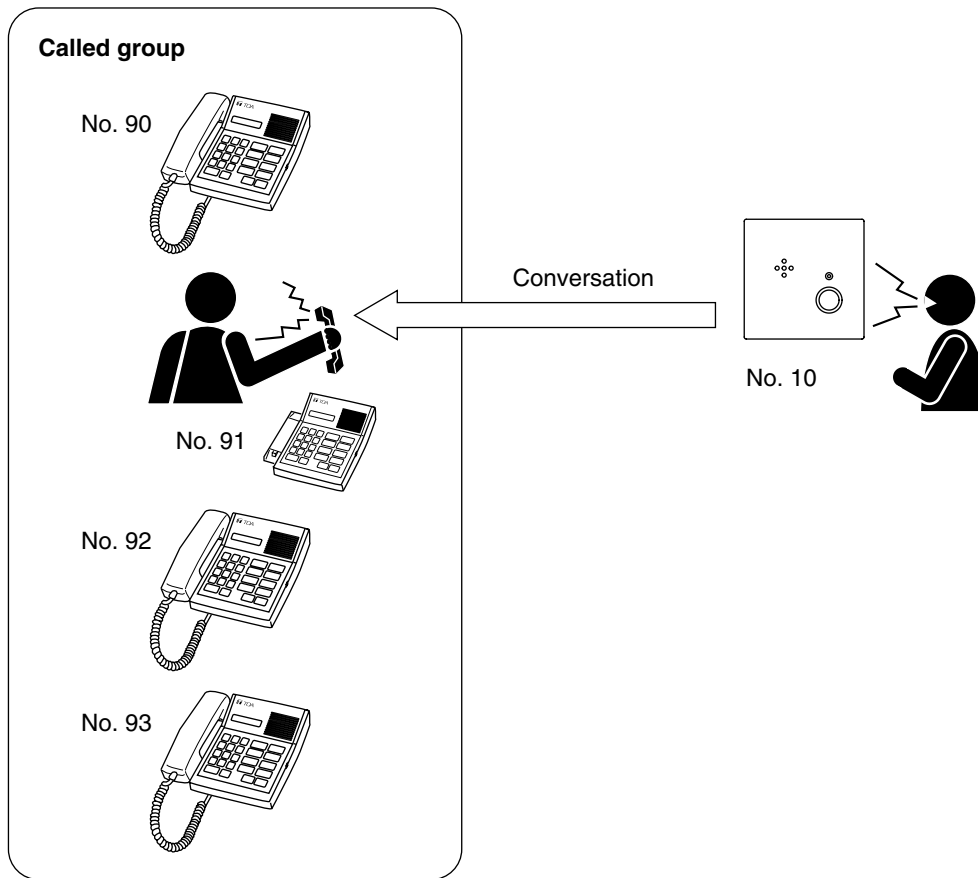

Note

The called master station (telephone) may respond to a group call in the same way as when it is called individually from a substation. (Refer to CHAPTER 2. BASIC OPERATION OF MASTER STATION.)

[Function details and restrictions]

The following explanations assume that a call has been made from a substation* to a master station.

- (1) Calls from Emergency substations as well as Normal stations become group calls.
- (2) When the group call representative station is placed in Call Forwarding mode, group calls are automatically rerouted to the designated receiving station without calling other group stations. If the receiving station (master station or telephone) is registered for Group Call operation, the call is made to all stations in the same group.
- (3) Even when the group call representative or member station is in Busy Call Forwarding or No-Answer Call Forwarding mode, the call is processed as a normal group call rather than being rerouted automatically.

* Calls from master station to master station will connect to the master station. (In this case, these calls will not be group calls.)

TRANSFER-RELATED FUNCTIONS

2. CALL TRANSFER

2.1. Function

- (1) Call transfer
A master station (or telephone) can transfer the conversation partner to another master station (or telephone).
- (2) Call Hold and Call Back
These functions enable the master station (or telephone) to temporarily put the current conversation on hold (Call Hold), and return to the original conversation (Call Back) after talking with a third party.

Note: Master station and telephone operation differs.

2.2. Call Transfer Operation

[Call hold]

Step 1. During a two-party conversation, press the transfer [XFER] key (or when using a telephone, press and release its hook switch). The original conversation is then placed on hold, and a holding tone is transmitted to the other party.

Step 2. Dial the third party's station number (example: [9][3]).

→ When the third party answers, the calling party can talk with the third party while leaving the original conversation on hold. (Call hold mode.)

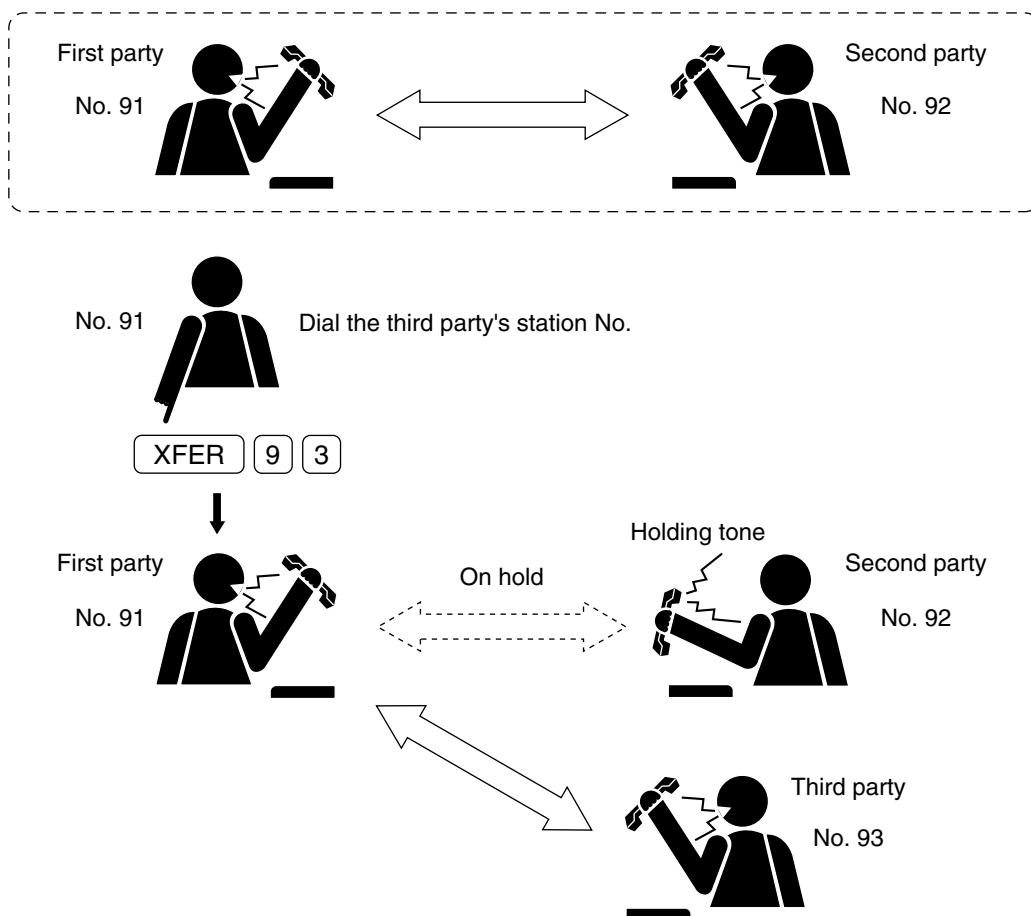

After completing the conversation with the third party, the calling party can either transfer the call or restore to the original conversation (call back).

[Transfer to the third party]

Step 3. To connect the third party with the waiting party, replace the handset or press the [C] key.
→ Conversation begins between the second and third parties.

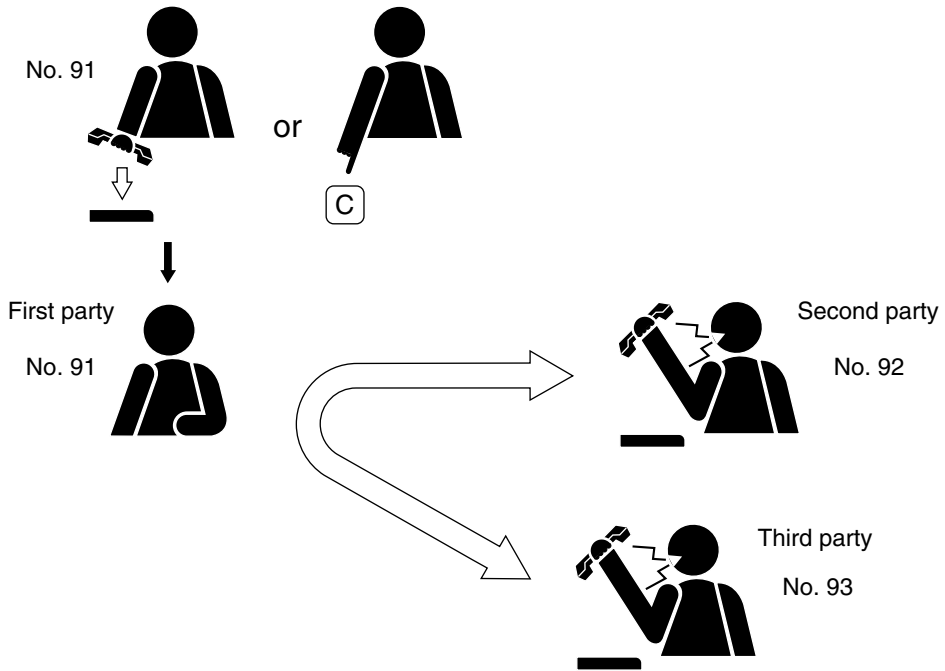

Exceptions

- (1) Conversations cannot be transferred to a substation. (The "Call Hold" function remains operational.)
- (2) Conversations cannot be transferred to an outside line telephone. (The "Call Hold" function is also disabled.)

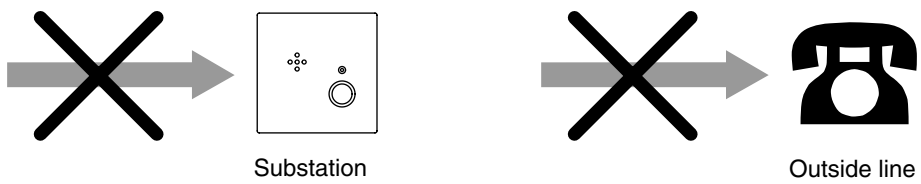

[Conversation restoration (Call back)]

Step 3. To return to the original conversation without transferring it, press the [XFER] key again*. The original two-party conversation can be resumed.

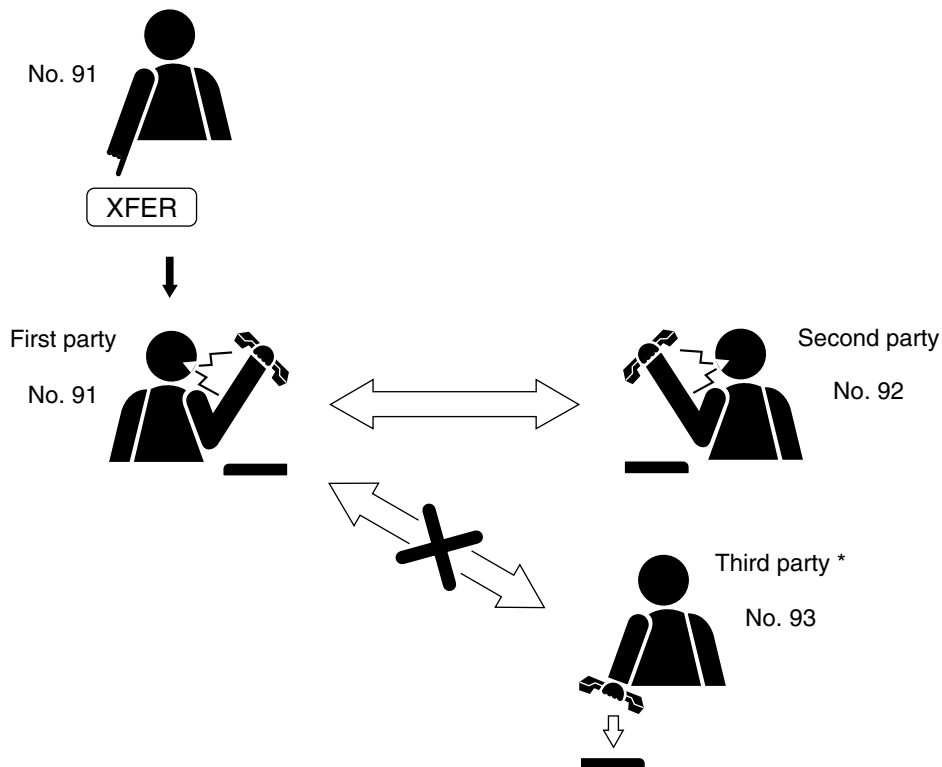

* The original conversation can be resumed even if the third party replaces the handset or presses the [C] key.

Notes

- The first party must neither replace the handset nor press the [C] key as doing so causes the conversation to terminate.
- If using a telephone, press and release its hook switch.

Exceptions

- (1) Conversations cannot be transferred to a substation. (The "Call hold" function remains operational.)
- (2) The "Call hold" function is disabled when the third party above is an outside line telephone.

CALL FORWARDING-RELATED FUNCTIONS

3. CALL FORWARDING

3.1. Function

When away from one's desk, incoming calls can be automatically forwarded to another receiving station. The receiving station* number can be registered at the original station (forwarding station). It is also possible to activate this feature from the destination receiving station. (See the figure in section 3.3. on the next page.)

* Both the forwarding and receiving stations must be either master stations or telephones. Calls cannot be forwarded to a substation.

[System pre-programming]

To use this function, enable the Call Forwarding function in system programming.

3.2. Registration Operation

3.2.1. Registration and cancellation at the original station

(1) Registration at the original station

First dial [*][6][0], and then the receiving station number (example: [9][3]) followed by [#].

A confirmation tone sounds to indicate registration completion, and the registered receiving station number* is displayed, returning the station to standby mode.

Display panel



Displays Call Forwarding mode.

* The station's name may be displayed.



(2) Registration cancellation at the original station

First dial [*][6][0], and then the original station number (example: [9][2]) followed by [#].

Cancellation completion is indicated by a confirmation tone. The station then returns to standby mode and the current time is shown on the display panel.

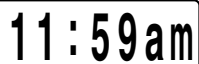

3.2.2. Registration and cancellation at the destination receiving station

(1) Registration at the receiving station

First dial [*][6][1], and then the original station number (example: [9][2]) followed by [#].

- Registration completion is indicated by a confirmation tone, and the receiving station returns to standby mode.
- The receiving station number* is displayed on the original station.

Original station's display panel



Displays Call Forwarding mode.

* The station's name may be displayed.

FWD:Office1

(2) Registration cancellation at the receiving station

First dial **[*][6][2]**, and then the original station number (example: **[9][2]**) followed by **[#]**.

Cancellation completion is indicated by a confirmation tone and the receiving station returns to standby mode. The indication of Call Forwarding displayed on the original station switches to that of the current time.



3.3. Call Forwarding Operation

[When the Call Forwarding registration is set]

Calls to the original station registered for Call Forwarding are automatically rerouted to the designated station without ringing the original station. (When the original station is a telephone, a brief call tone is sounded, then the call is automatically forwarded.)

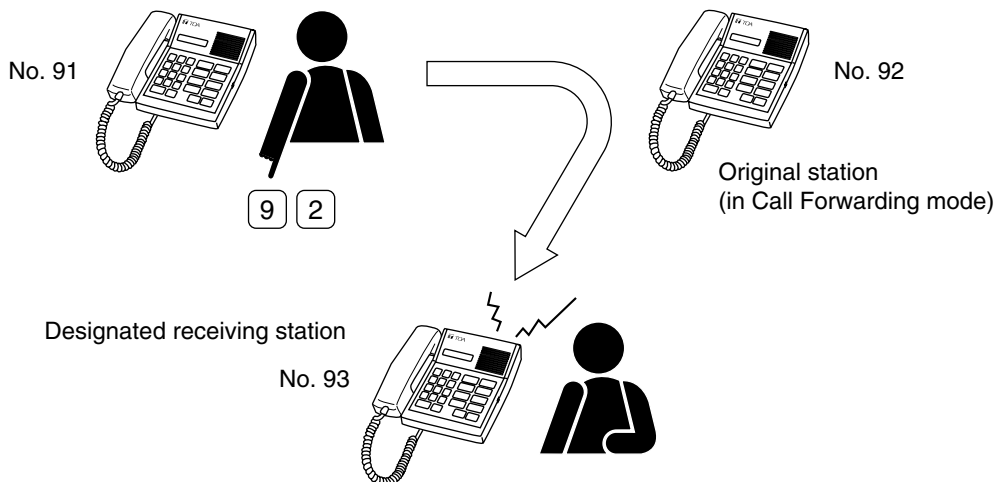

[Exceptions]

- (1) The designated receiving station can directly call the original station without interference from the call forwarding function.
- (2) Even if the designated receiving station is also registered for a Call Forwarding-related function, calls are no longer forwarded from that receiving station.

4. TIME-BASED CALL FORWARDING

4.1. Function

All incoming calls to the original station* (forwarding station) can be automatically rerouted to the designated master station* (receiving station) during a specific period of the day.

* Both the forwarding and receiving stations must be either master stations or telephones. Calls cannot be forwarded to a substation. (See the figure in section 4.3. on the next page.)

[System pre-programming]

- (1) To use this function, the Time-Based Call Forwarding function must be enabled in system programming.
- (2) The forwarding interval (start and end times) can be registered in the system programming. (Registration can only be performed for an entire exchange. Different times cannot be set for different stations on the same exchange.)

4.2. Registration and Cancellation

Use the original station to register or cancel this function.

4.2.1. Registration

First dial [*][6][3], and then the receiving station number (example: [9][3]) followed by [#].
Registration completion is indicated by a confirmation tone.

[If the current time is in the transfer interval]

The registered receiving station number* is then displayed on the original station's display panel to indicate that the original station is in Time-Based Call Forwarding mode.

Display panel

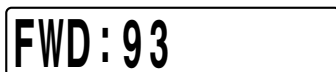

Displays Time-Based Call Forwarding mode.

* The name of the station may be displayed.



[If the current time is not in the transfer interval]

The current time is displayed and the station returns to standby mode.

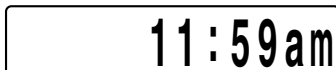

4.2.2. Cancellation

First dial [*][6][3], and then the original station number (example: [9][2]) followed by [#].

Cancellation completion is indicated by a confirmation tone. The display panel then displays the current time and the station returns to standby mode.

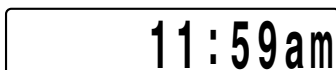

4.3. Time-Based Call Forwarding Operation

[When the Time-Based Call Forwarding registration is set]

Step 1. When the preset forwarding start time arrives, the following indication is displayed on the station display panel, indicating that the station* (example: 93) is in Time-Based Call Forwarding mode.

Display panel

FWD:93

Indicates the station is in Time-Based Call Forwarding.

* The name of the station may be displayed.

FWD:Office1

Step 2. Calls to the original station (forwarding station) are automatically rerouted to the receiving station without sounding a call tone at the original station. (If the original station is a telephone, the call is automatically forwarded after sounding a brief call tone.)

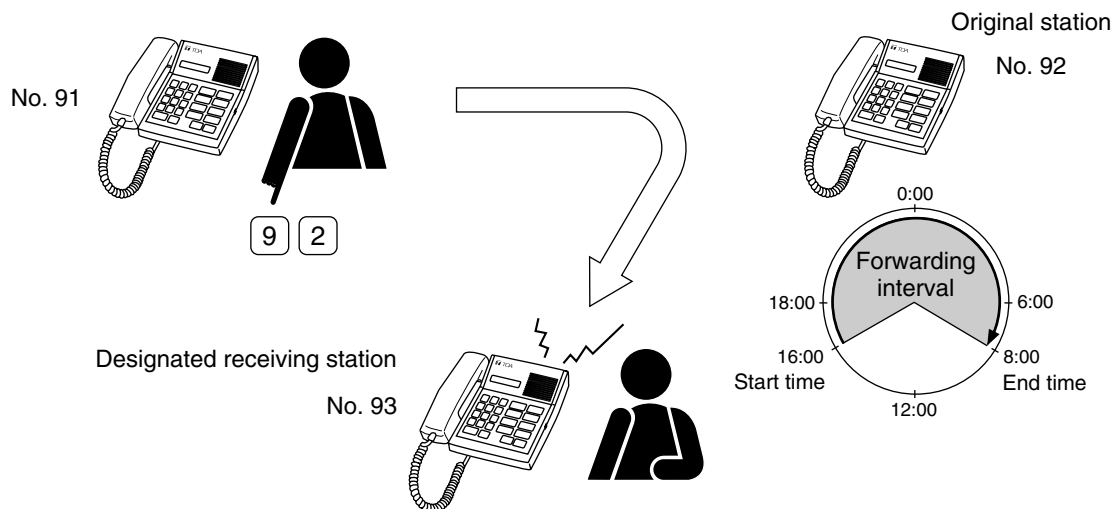

Step 3. When the forwarding interval end time arrives, the indication of Time-Based Call Forwarding is extinguished. The current time is then displayed, and the station returns to normal mode.

11:59am

[Exceptions]

- (1) The designated receiving station can directly call the original station without interference from the call forwarding function.
- (2) Even if the designated receiving station is also registered for a Call Forwarding-related function, calls are no longer forwarded from that receiving station.

5. NO-ANSWER CALL FORWARDING

5.1. Function

Calls to the original station* (forwarding station) are automatically rerouted to the designated receiving station* if the called party does not respond within a preset period of time. (See the figure in section 5.3. on the next page.)

* Both the forwarding and receiving stations must be either master stations or telephones. Calls cannot be transferred to a substation.

[System pre-programming]

- (1) To use this function, the No-Answer Call Forwarding function must be enabled in system programming.
- (2) Register a variable "no-response" time of 1 – 99 seconds (in 1 second units) in the system programming. (Registration can only be performed for an entire exchange. Different times cannot be set for different stations on the same exchange.)

5.2. Registration and Cancellation

Use the original station to register or cancel this function.

5.2.1. Registration

First dial `[*][6][4]`, and then the receiving station number (example: `[9][3]`) followed by `[#]`.

Registration completion is indicated by a confirmation tone. The current time is then displayed, and the station is placed in standby mode.

5.2.2. Cancellation

First dial `[*][6][4]`, and then the original station number (example: `[9][2]`) followed by `[#]`.

Cancellation completion is indicated by a confirmation tone. The current time is then displayed and the station is placed in standby mode.

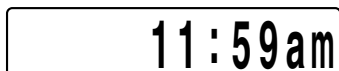

11:59am

5.3. No-Answer Call Forwarding Operation

[When the No-Answer Call Forwarding registration is set]

- The station display panel displays the current time.
- Calls to the original station (forwarding station) are automatically rerouted to the receiving station if no response is made within the specified period of time. When several calls are simultaneously made to the original station, the original station begins its time count upon receiving the first call, and all waiting stations are forwarded when the set interval time elapses.

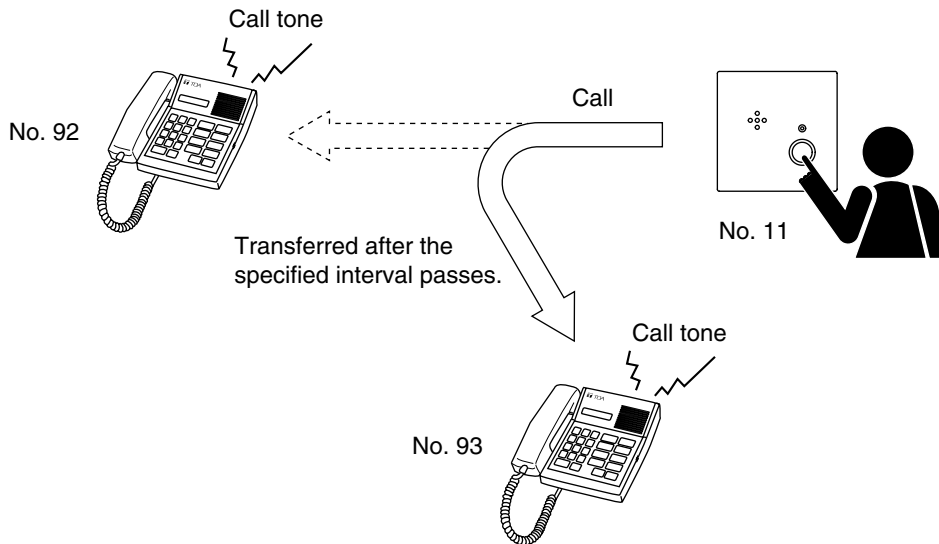

[Exceptions]

- (1) The designated receiving station can directly call the original station without interference from the call forwarding function.
- (2) When the designated receiving station is also registered for No-Answer Call Forwarding, the call is further rerouted to the second station.
- (3) When the designated receiving station is busy, the original station continues to be called.
- (4) The No-Answer Call Forwarding function is disabled when the designated receiving station has already been registered for Call Forwarding.
- (5) The No-Answer Call Forwarding function does not interfere with a substation call to a designated Group Call representative station that is registered for No-Answer Call Forwarding. (The group call designation is given priority.)

6. BUSY CALL FORWARDING

6.1. Function

Calls to a busy station* are automatically forwarded to a designated station*.

* The station which forwards calls (forwarded station) and the station to which calls are forwarded (receiving station) must be either a master station or a telephone. Calls cannot be forwarded to a substation.

[System pre-programming]

To use this function, the Busy Call Forwarding function must be enabled in system programming.

6.2. Registration and Cancellation

Use the original station to register or cancel this function.

6.2.1. Registration

First dial [*][6][5], and then the receiving station number (example: [9][3]) followed by [#].

Registration completion is indicated by a confirmation tone and the station is placed in standby mode.

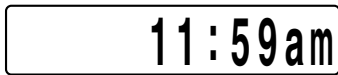

6.2.2. Cancellation

First dial [*][6][5], and then the original station number (example: [9][2]) followed by [#].

Cancellation completion is indicated by a confirmation tone. The current time is then displayed and the station returns to standby mode.

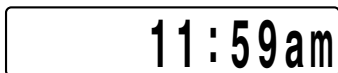

6.3. Busy Call Forwarding Operation

Calls to a busy station (example: 92) are automatically forwarded to another designated station (example: 93).

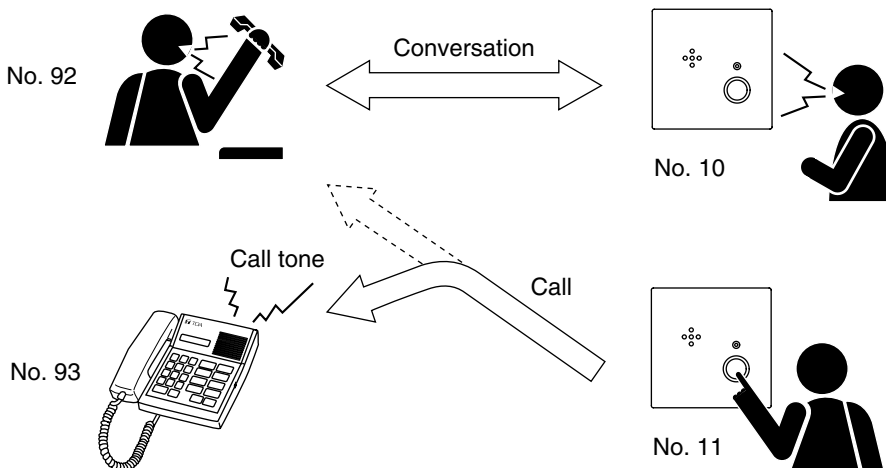

[Exceptions]

- (1) When the designated receiving station (example: 93) is busy, all succeeding calling parties must wait. (Even Station 93 is also registered for Busy Call Forwarding, only the first transfer attempt to this station is made, followed by no further attempts. The waiting stations wait until the line of Station 93 becomes free.) As soon as Station 93 finishes its conversation, the next calling party is automatically put through to that station. When the line of the original station (example: 92) is freed while Station 93 is still busy, the calling party is connected to Station 92 without being transferred.
- (2) The designated receiving station (93) can directly call the original station (92) without interference from the call forwarding function.
- (3) The Busy Call Forwarding function is disabled when the designated receiving station has already been registered for Call Forwarding.
- (4) The Busy Call Forwarding function does not interfere with a substation call to a Group Call representative station that is registered for Busy Call Forwarding. (The group call designation is given priority.)

MONITOR-RELATED FUNCTIONS**7. SCAN MONITOR****7.1. Function**

Any master station can scan a designated group of substations for audio monitoring of each substation. (See the figure on the next page.)

[System pre-programming]

- (1) Substations to be monitored (up to 16) can be registered for each master station in system programming.
- (2) Monitor interval times of 1 – 99 seconds (in 1 second units) for each master station can be registered in the system programming.

7.2. Scan Monitor Operation**Step 1. Automatic scanning**

Press [*][2] at the master station.

- Scanning begins and automatically cycles through the substation group in the registered order and at the registered time interval until manually stopped.
- The number or name of the substation being monitored is displayed on the master station.
- The handset may also be used for monitoring by simply lifting it.

Step 2. Manual scanning**(1) Automatic Scanning Stop & Restart**

To continue monitoring a particular substation, press the [0] key to stop automatic monitoring scan at that station. Pressing the [0] key again will restart the automatic scanning sequence.

(2) Scan FORWARD

Pressing the [#] key advances monitoring by one substation.

(3) Scan BACK

Pressing the [*] key reverses monitoring by one substation.

(4) Talking to the substation

Press the [PTT] key to talk to the substation.

Step 3. Scan monitor termination

To terminate the Scan Monitor operation, either press the [C] key or replace the master station handset.

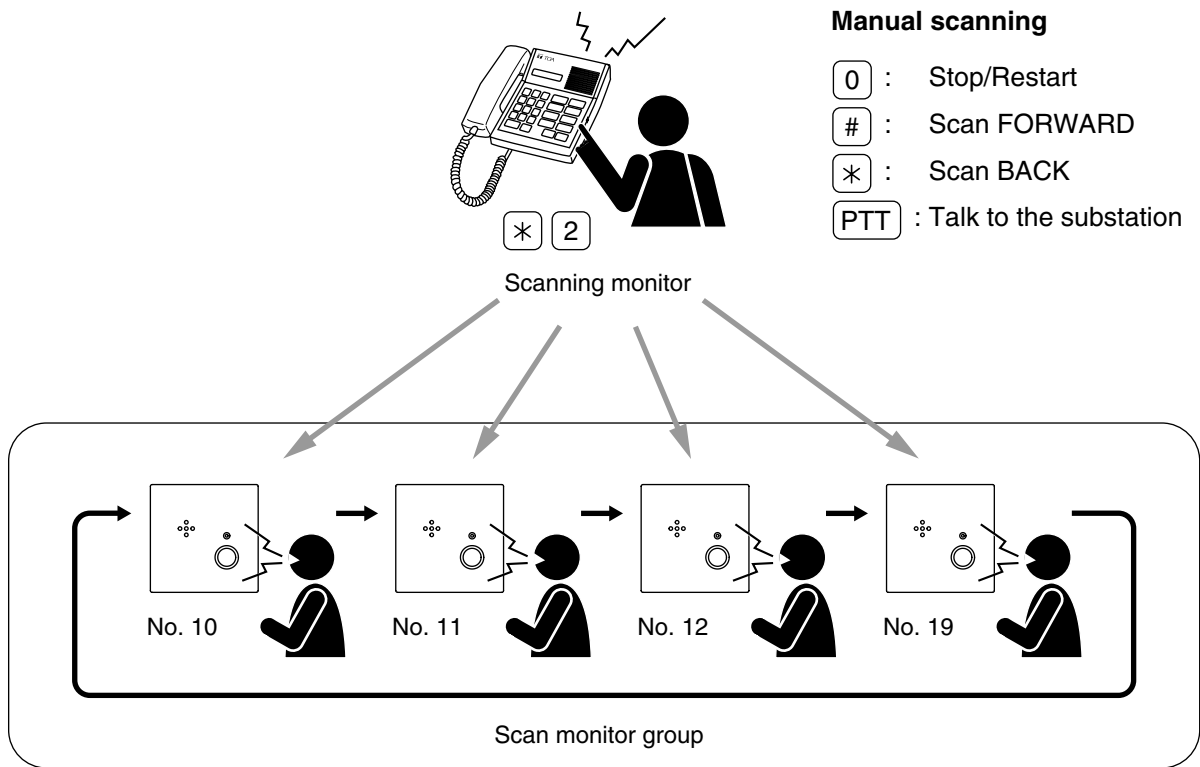

[Scan Monitor operation details]

- (1) No voice is transmitted from the master station to the substation being monitored unless the master station's [PTT] key is pressed.
- (2) When the substation to be monitored is busy, the busy indication is displayed together with a busy tone at the master station.
- (3) Incoming calls to the master station in the process of scanning substations are indicated on the calling party display. To respond to such calls, first terminate monitoring by either pressing the [C] key or replacing the handset, and then answer.

PAGING-RELATED FUNCTIONS

This function permits a master station or a telephone to broadcast to multiple substations*¹ or external public address equipment. The VS-900 system offers the following four paging methods:

- (1) Zone paging broadcasts to individual zones*²
- (2) Simultaneous all-zone paging broadcasts*²
- (3) Emergency paging broadcast to entire areas*³
- (4) External sound source distribution to individual zones*²

*¹ Only Emergency paging can be broadcast additionally to master stations.

*² Except Emergency substations because they can not be assigned to any zone.

*³ Including Emergency substations.

8. ZONE PAGING

8.1. Function

Permits paging to up to 19 individual zones (01 – 19) established by combining multiple substations with external public address system equipment. Two or more individual zones can simultaneously be selected.

[System pre-programming]

- (1) The number of zone number digits (1 or 2 digits) can be registered in system programming.
 Single digit: Zone Nos. 1 – 9
 Double digit: Zone Nos. 01 – 19
 - (2) Substation numbers and selective external public address equipment outputs to be included in each zone can be registered in the system programming. Up to 1,024 substations and up to 16 selective outputs can be registered per zone.
- Note:** Only 1 voice output is made available for paging to external equipment. It is impossible for 2 or more persons to simultaneously initiate paging.

8.2. Zone Paging Dialing Operation

- Step 1.** First press [*][8], and then the desired zone numbers (example: [2] & [3]) followed by [#].
 Up to 9 (19) zones can simultaneously be selected.
- Step 2.** A paging pre-announcement tone is transmitted to the selected zones.
 Place a paging call with the handset either off-hook or on-hook.*¹
- Step 3.** To terminate the broadcast, replace the handset or press the [C] key.*²

*¹ If using a telephone, lift the handset to place a paging call.
 *² If using a telephone, replace the handset to terminate the paging call.

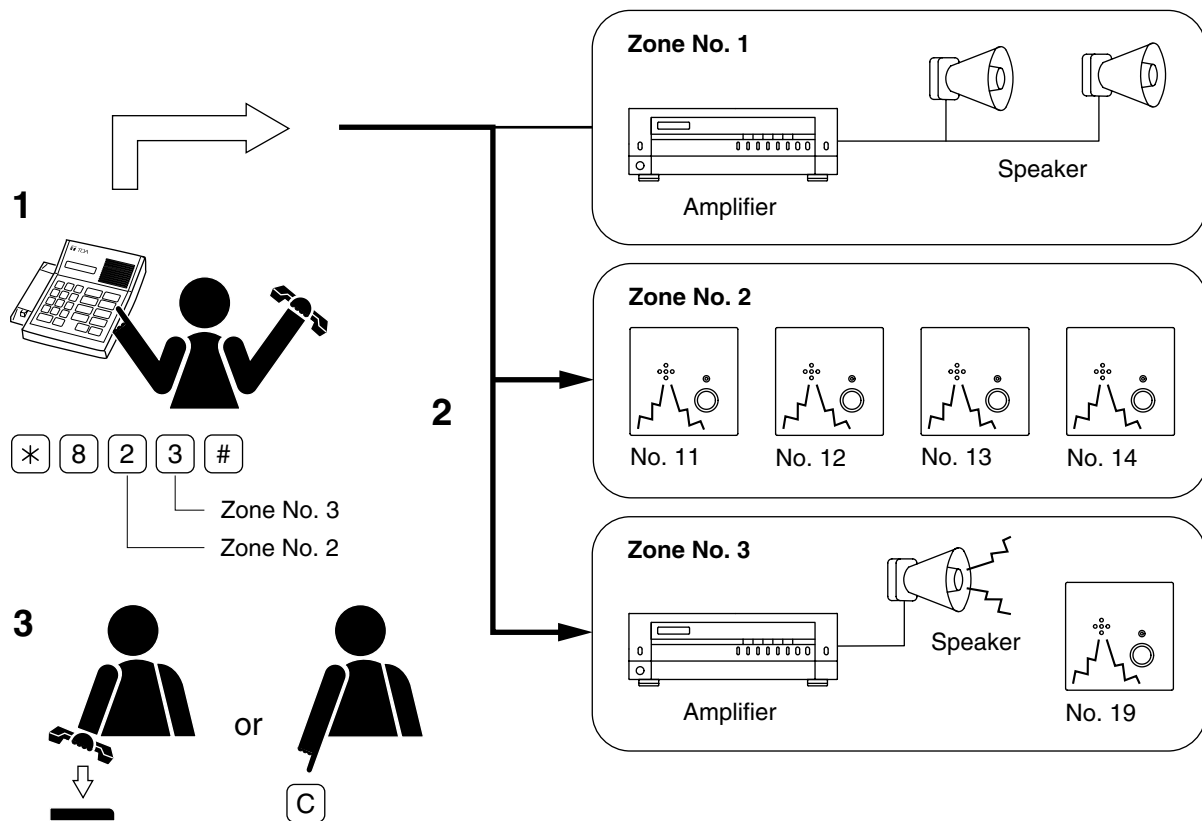

[Paging Priority order]

Current zone paging will be interrupted when the following paging or broadcast functions are initiated:

- 1. Emergency paging
- 2. Emergency conference
- 3. External source distribution
- 4. All-zone paging

Note

Current paging could be suddenly cut off when Emergency Paging, Emergency Conference or External Source Distribution with higher priority is initiated.

9. ALL-ZONE PAGING

9.1. Function

Paging calls can be simultaneously made to substations and external public address equipment in the all programmed zones. (Paging calls are not made to substations and external public address equipment not assigned to zones.)

[System pre-programming]

- (1) The number of digits (1 or 2) of an all-zone paging access number ([0] or [0][0]) can be registered in system programming.
- (2) Substation numbers and selective external public address equipment outputs to be included in each zone can be registered in the system programming. Up to 1,024 substations and up to 16 selective outputs can be registered per zone.

9.2. All-Zone Paging Dialing Operation

Step 1. First dial [*][8], and then an all-zone paging access number ([0] or [0][0]) followed by [#].

[*][8][0][#] (When a single-digit access number is selected)

[*][8][0][0][#] (When a double-digit access number is selected)

Step 2. A paging pre-announcement tone is transmitted to all zones.

Place the paging call with the handset either off-hook or on-hook.*¹

Step 3. To terminate the broadcast, replace the handset or press the [C] key.*²

*¹ If using a telephone, lift the handset to place a paging call.

*² If using a telephone, replace the handset to terminate the paging call.

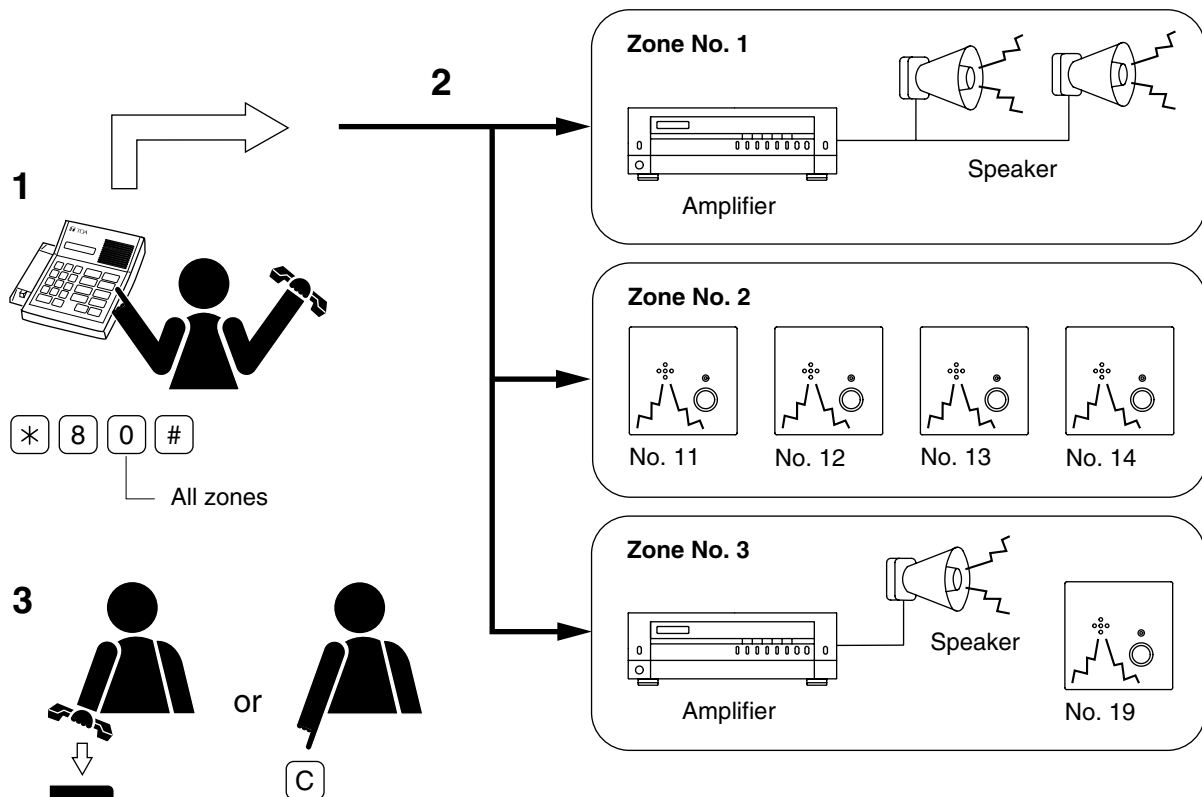

[Paging Priority order]

Current all-zone paging will be interrupted when the following paging functions are initiated:

1. Emergency paging
2. Emergency conference
3. External source distribution

10. EMERGENCY PAGING

10.1. Function

Paging calls can be made to all connected master stations, substations, and external public address equipment simultaneously.

[System pre-programming]

Master stations that can place Emergency Paging calls must be registered in the system programming.

10.2. Emergency Paging Dialing Operation

Step 1. Dial [*][*][*][*] from the master station or telephone.

Step 2. A paging pre-announcement tone is transmitted to all substations, master stations (and telephones), and external public address equipment. (A call tone sounds at the telephone.^{*1})
Make an announcement with the handset either lifted or unlifted.^{*2}

Step 3. To terminate the announcement, replace the handset or press the [C] key.^{*3}

^{*1} When a telephone is called, the emergency paging can be heard if the handset is lifted. The call tone sounds again when the handset is replaced, and the broadcast can be heard when the handset is lifted.

^{*2} If using a telephone, lift the handset to place a paging call.

^{*3} If using a telephone, replace the handset to terminate the paging call.

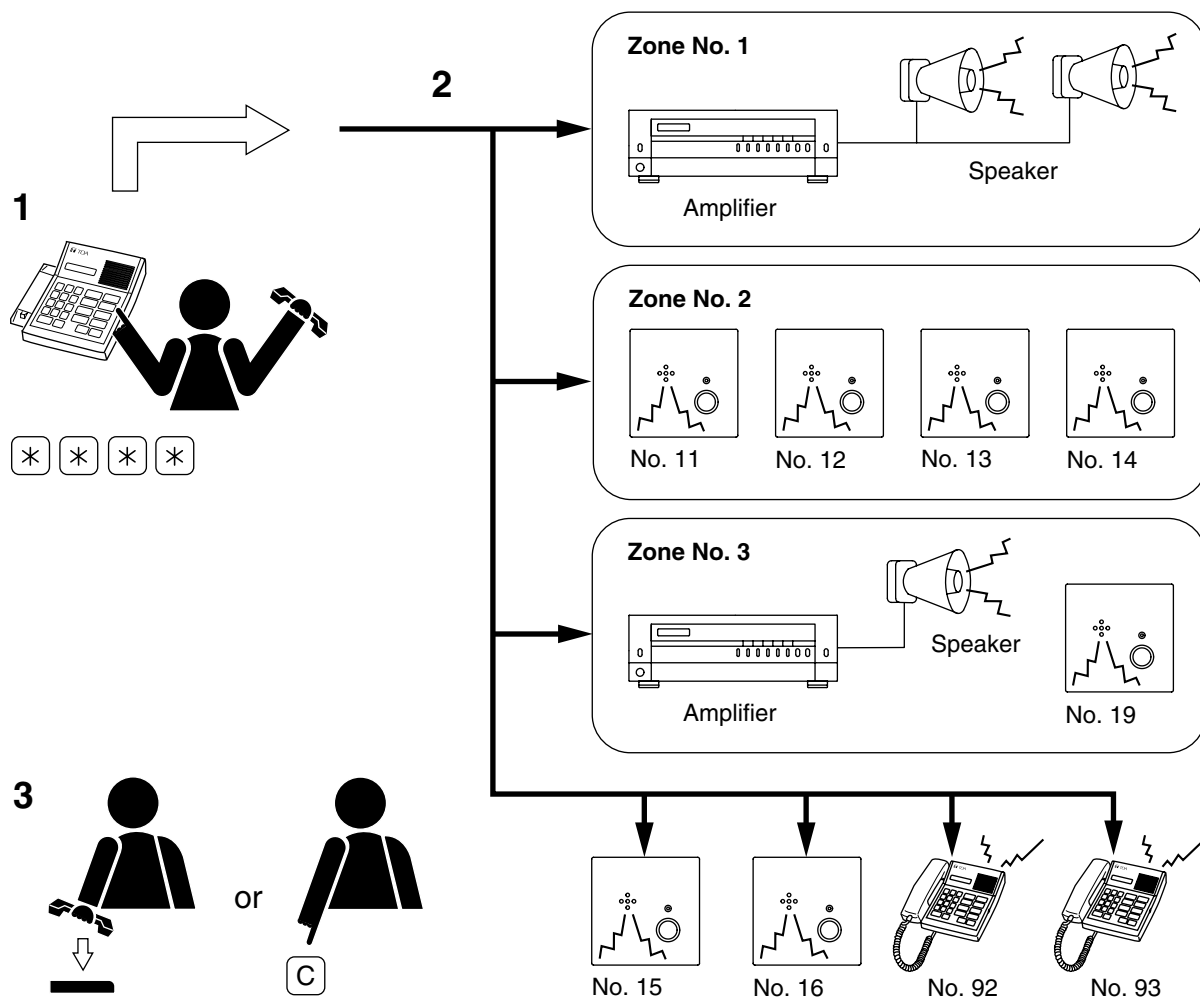

[Paging Priority order]

Emergency Paging calls interrupt all current conversations and broadcasts, and such interrupted conversations or broadcasts are not restored after paging completion.

11. EXTERNAL SOURCE DISTRIBUTION

11.1. Function

By activating the input, external sound sources can be distributed to pre-programmed paging zones. Permits source distribution to up to 19 individual zones (01 – 19) established by combining multiple substations with external public address system equipment. Two or more individual zones can simultaneously be selected.

[System pre-programming]

Up to 9 (19) paging zones can be registered for each activation input (up to 4 inputs) in system programming. (Up to 1,024 substations and up to 16 selective external public address equipment outputs to be included in each zone are registered in the Zone Paging system programming.)

11.2. External Source Distribution Operation

(1) When the activation input is made, announcements from external equipment are made to the pre-programmed paging zones. The announcements are terminated when the activation input is broken.

Note: Multiple activation inputs cannot be used simultaneously.

(2) There are 4 activation inputs, and 1 audio input.

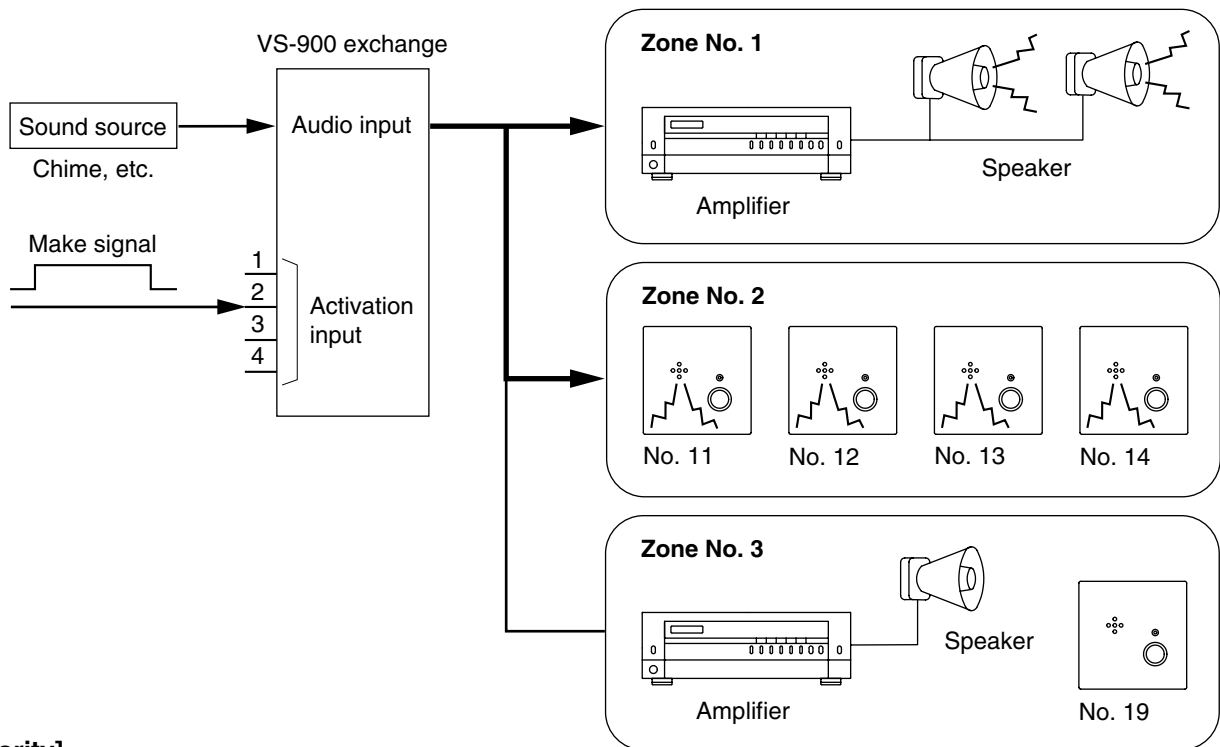

[Priority]

When an activation input accepts a make pulse, its rising edge allows the external source distribution operation to perform. During its operation, any other input will not accept a make.

12. PAGING TIME-OUT

Paging calls that exceed a set time limit are automatically terminated. (This function is used mainly to prevent the line from being occupied because the user forgot to turn off the function.) The Time-Out function is disabled when an emergency paging call is placed.

[System pre-programming]

- Program whether to [Enable] or [Disable] the Paging Time-Out function.
- Paging time-out (10 – 990 seconds in 10 second units) common to both Individual Zone and All-Zone Paging functions can be registered in the system programming.

13. PAGING REDIAL

13.1. Function

This function permits redialing the last-paged zone by simple key operations.

13.2. Paging Redialing Operation

Step 1. Dial [*][8][#] at the master station or telephone.

Step 2. A paging pre-announcement tone is transmitted to the last-paged zones, including All-zone Paging. Make an announcement with the handset either lifted or unlifted.*¹

Step 3. To terminate the page, either replace the handset or press the [C] key.*²

*¹ If using a telephone, lift the handset to place a paging call.

*² If using a telephone, replace the handset to terminate the paging call.

Note: The Paging Redialing function cannot be used for Emergency Paging.

TELEPHONE-RELATED FUNCTIONS

Outside telephone lines can be connected to the VS-900 system, permitting the system's master stations to make or receive outside line telephone calls.

14. OUTGOING TELEPHONE CALLS

[System pre-programming]

A single-digit outside line access number ([0]-[9]) must first be programmed.

14.1. Outside Line Dialing Operation

Step 1. Dial the registered outside line access number (example: [0]).
A dial tone is heard.

Step 2. Dial the telephone number.

Step 3. Start the conversation when the called party answers.

Step 4. Replace the handset or press the [C] key after conversation completion.

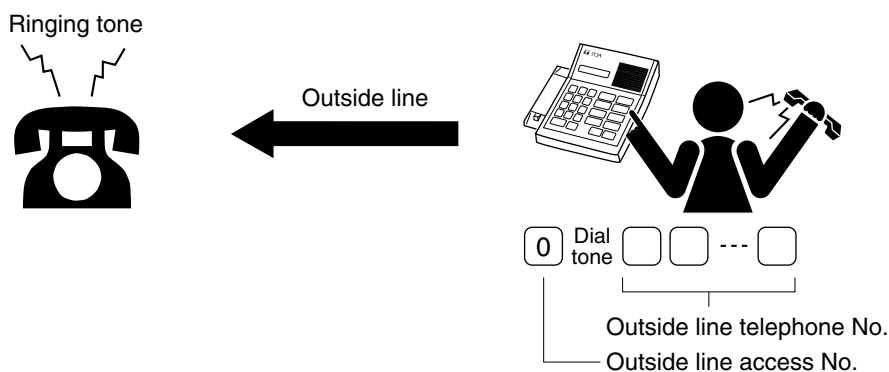

15. INCOMING OUTSIDE LINE CALLS (DIRECT-IN LINE)

15.1. Direct-In Line Function

When an outside telephone call is received, a call tone sounds at the registered representative station* and up to 3 member stations*.

[System pre-programming]

One representative station* and up to 3 member stations* must be registered in the system programming to receive outside line calls.

* Both the representative and member stations must be master stations or telephones.

Note: Both the representative and member stations must be connected to the same exchange connected to the outside telephone line.

15.2. Incoming Outside Line Call Operation

Step 1. A call tone sounds at up to 4 stations.

Step 2. When one of the stations lifts its handset or presses the [PTT] key*, the call tones sounding at other stations stop, permitting the conversation to begin.

* For telephones, lift the handset.

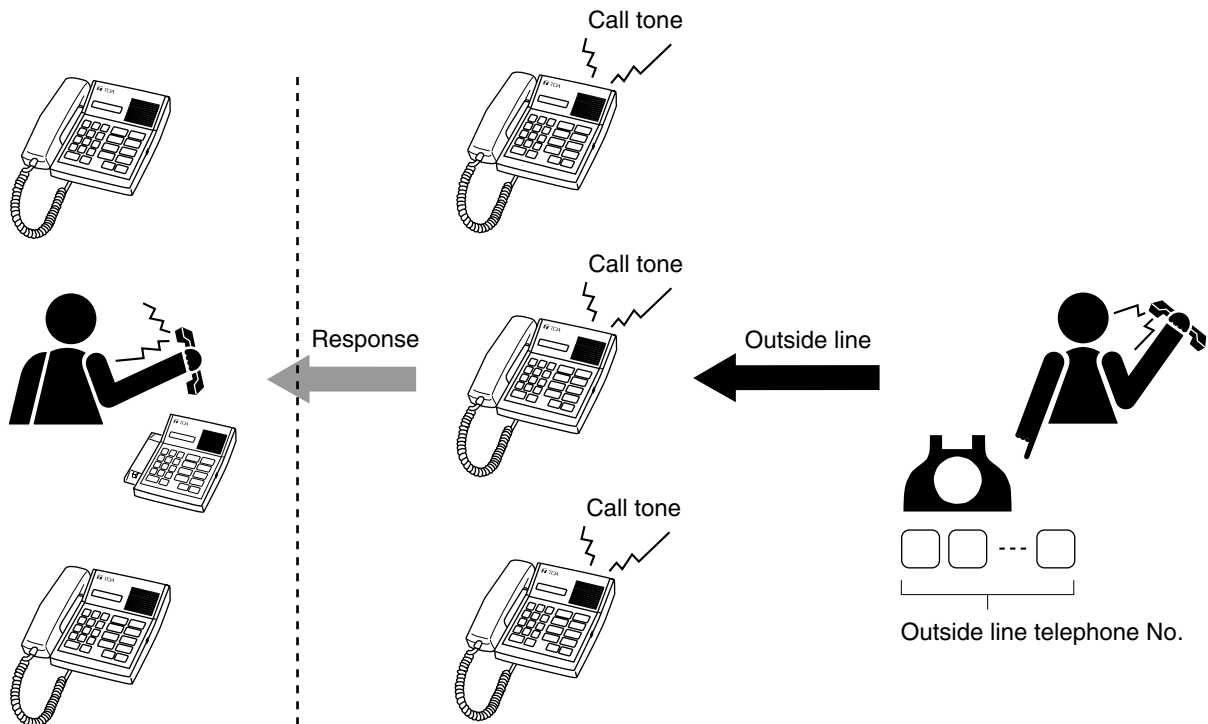

16. INCOMING OUTSIDE LINE CALLS (DIRECT-IN DIALING)

16.1. Direct-In Dialing Function

Outside line calling parties can be connected to a desired master station (telephone) or substation by directly dialing the station number.

16.2. Incoming Outside Line Call Operation

Step 1. When a call is received from the outside line, the VS-900 system's exchange automatically responds by transmitting a dial tone to the calling party.

Step 2. After hearing the dial tone, dialing the station number will connect the calling station to the called party.

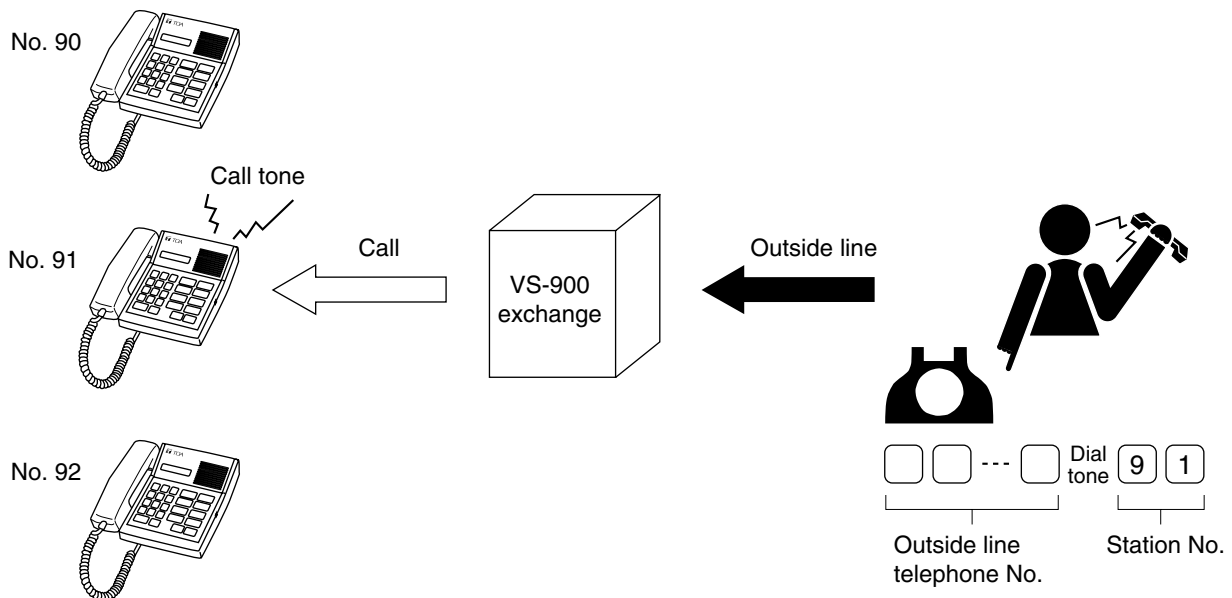

[Operation details]

- (1) If the calling party does not dial a station number within 10 seconds after the confirmation tone is transmitted, the registered Direct-In Line stations are called. (See the figure in section 15.2. on the previous page.)
- (2) If the called station does not answer for 30 seconds or more after the calling party dials the station number, the call is canceled.

Note: The Call Forwarding, Busy Call Forwarding or No-Answer Call Forwarding function can be used unless the station to which calls are transferred is a outside line telephone.*¹ *²

*¹ Calls can be automatically forwarded if the station called from the outside line is currently in Call Forwarding, Busy Call Forwarding or No-Answer Call Forwarding mode (when the station to which calls are transferred is a master station or telephone).

*² Calls cannot be automatically forwarded when the station called from the outside line is currently in Outside Line Call Forwarding, Outside Line Busy Call Forwarding, or Outside Line No-Answer Call Forwarding mode (when the station to which calls are transferred is a outside line telephone).

17. OUTSIDE LINE CONNECTION TIME-OUT

- The duration of connection with the outside line telephone can be limited to automatically terminate conversations.
- When the limited time is reached, a warning signal tone is transmitted to both the calling and called parties to terminate the conversation.

[System pre-programming]

- (1) Program whether to [Enable] or [Disable] the Connection Time-Out function.
- (2) Set a connection time limit of 1 – 99 minutes in 1 minute unit.

18. OUTSIDE LINE CONVERSATION RECORDING

- Connecting an external recording device permits recording of outside line telephone conversations.
- The external control output is made when the outside line telephone is connected, and is broken when the telephone is disconnected. (For equipment connections and operations, refer to the "VS-900 INSTALLATION MANUAL.")

19. OUTSIDE LINE CALL FORWARDING

19.1. Function

All calls can be automatically rerouted to the designated receiving telephone by registering the outside line access number at the original master station or telephone. (See the figure in section 19.3. on the next page.)

[System pre-programming]

- (1) To use this function, the Call Forwarding function must be enabled in system programming.
- (2) The receiving telephone number can individually be registered for each master station (or telephone) in the system programming.

19.2. Registration and Cancellation

Use the original station to register or cancel this function.

19.2.1. Registration

First dial [*][6][0], and then the outside line access number (example: [0]) followed by [#].

Registration completion is indicated by a confirmation tone, and the exchange number and the line number of the outside line are displayed. The station then returns to standby mode.

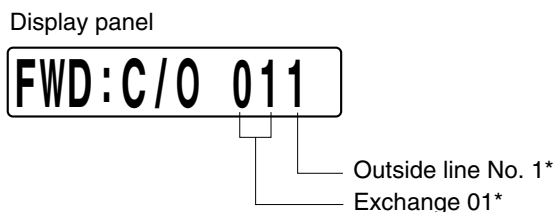

* The name of the exchange/outside line number may be displayed.



19.2.2. Cancellation

First dial [*][6][0], and then the original station number (example: [9][2]) followed by [#].

Cancellation completion is indicated by a confirmation tone. The station then returns to standby mode and the current time is shown on the display panel.

11:59am

19.3. Outside Line Call Forwarding Operation

Calls to the original station are automatically rerouted to the registered outside line telephone without sounding a call tone at the original station. (When the original station is a telephone, a brief call tone is sounded, then the call is automatically transferred.)

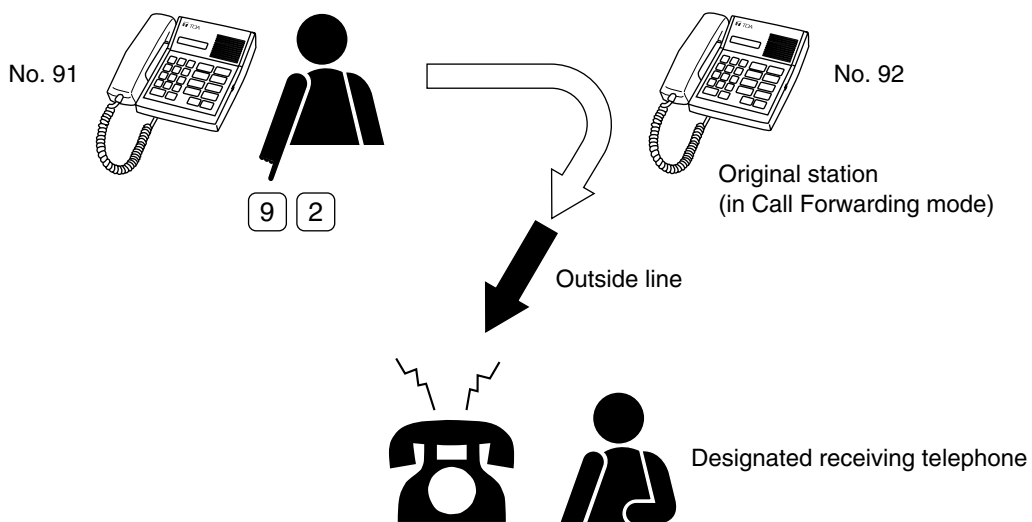

[Exceptions]

All outside line telephones can directly call the original station without interference from the call forwarding function.

20. TIME-BASED OUTSIDE LINE CALL FORWARDING

20.1. Function

All incoming calls to the original master station or telephone can be automatically rerouted to the designated outside line telephone during a specific period of the day. (See the figure in section 20.3. on the next page.)

[System pre-programming]

- (1) To use this function, the Call Forwarding function must be enabled in system programming.
- (2) Register the receiving outside line telephone number individually for each master station (or telephone) in the system programming.
- (3) The forwarding interval (start and end times) can be registered in the system programming. (Registration can only be performed for an entire exchange. Different times cannot be set for different stations on the same exchange.)

20.2. Registration and Cancellation

Use the original station to register or cancel this function.

20.2.1. Registration

First dial [*][6][3], and then an outside line access number (example: [0]) followed by [#].
Registration completion is indicated by a confirmation tone.

[If the current time is in the forwarding interval]

The exchange number and the line number of the outside line are displayed on the original station's display panel to indicate that the original station is in Time-Based Call Forwarding active mode.

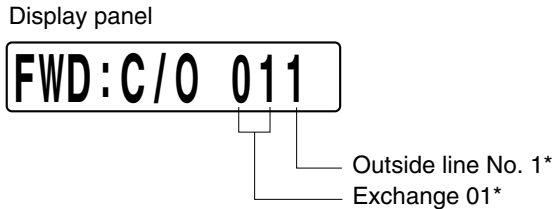

* The name of the exchange/outside line number may be displayed.



[If the current time is not in the forwarding interval]

The current time is displayed and the station returns to standby mode.

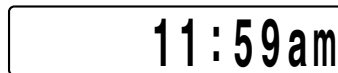

20.2.2. Cancellation

First dial [*][6][3], and then the original station number (example: [9][2]) followed by [#].

Cancellation completion is indicated by a confirmation tone. The station then returns to standby mode and the current time is shown on the display panel.

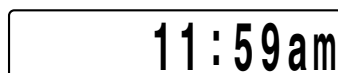

20.3. Time-Based Outside Line Call Forwarding Operation

[When the Time-Based Call Forwarding registration is set]

Step 1. When the preset forwarding start time arrives, the following indication is displayed on the station display panel, indicating that the station is in Time-Based Outside Line Call Forwarding active mode.

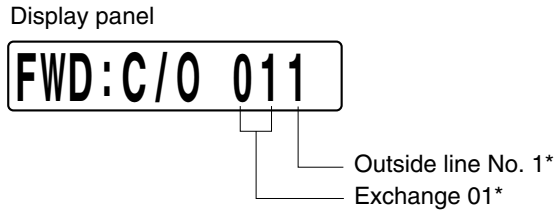

* The name of the exchange/outside line number may be displayed.



Step 2. Calls to the original station (forwarding station) are automatically rerouted to the designated outside line telephones without sounding a call tone at the original station. (If the original station is a telephone, the call is automatically forwarded after sounding a brief call tone.)

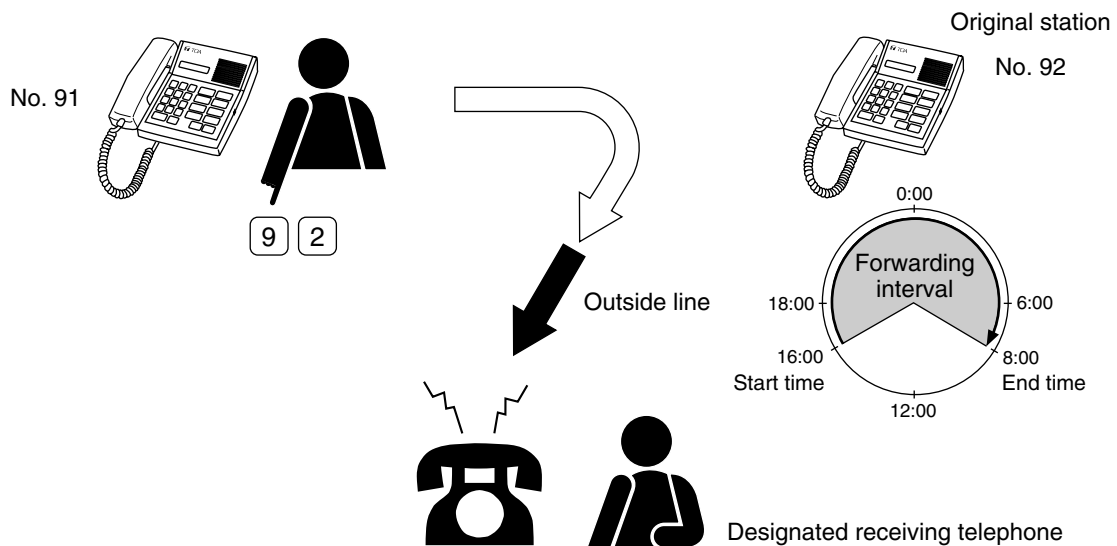

[Exception]

All outside line telephones can directly call the original station without interference from the call forwarding function.

21. OUTSIDE LINE NO-ANSWER CALL FORWARDING

21.1. Function

Calls to the original station (forwarding station) are automatically rerouted to the designated receiving telephone if the called party does not respond within a preset period of time. (See the figure in section 21.3. on the next page.)

[System pre-programming]

- (1) To use this function, the Outside Line No-Answer Call Forwarding function must be enabled in system programming.
- (2) Register a variable "no-response" time of 1 – 99 seconds (in 1 second units) in the system programming. (Registration can only be performed for an entire exchange. Different times cannot be set for different stations on the same exchange.)
- (3) The receiving telephone number can individually be registered for each master station (or telephone) in the system programming.

21.2. Registration and Cancellation

Use the original station to register or cancel this function.

21.2.1. Registration

First dial [*][6][4], and then the outside line access number (example: [0]) followed by [#].

Registration completion is indicated by a confirmation tone. The current time is then displayed, and the station is placed in standby mode.

21.2.2. Cancellation

First dial [*][6][4], and then the original station number (example: [9][2]) followed by [#].

Cancellation completion is indicated by a confirmation tone. The current time is then displayed and the station is placed in standby mode.

11:59am

21.3. Outside Line No-Answer Call Forwarding Operation

[When the Outside Line No-Answer Call Forwarding registration is set]

- The station display panel displays the current time.
- Calls to the original station (forwarding station) are automatically rerouted to the receiving telephone if no response is made within the specified period of time.

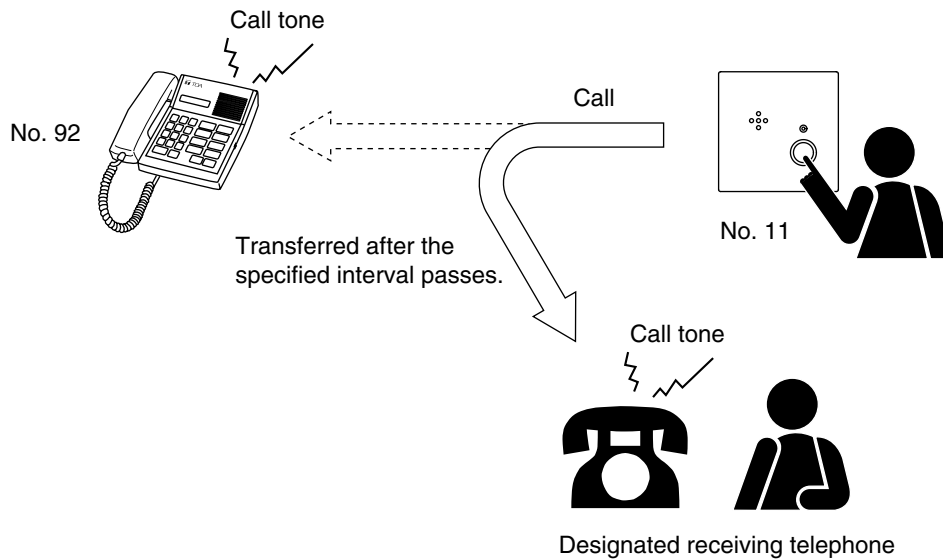

[Exceptions]

- (1) The outside line telephone can directly call the original station without interference from this call forwarding function.
- (2) Calls are not transferred when the designated outside line telephone is busy.
- (3) The Outside Line No-Answer Call Forwarding function does not interfere with a substation call to a designated Group Call representative station that is registered for Outside Line No-Answer Call Forwarding. (The group call designation is given priority.)

22. OUTSIDE LINE BUSY CALL FORWARDING

22.1. Function

Calls to a busy station are automatically forwarded to a designated telephone.

[System pre-programming]

- (1) To use this function, the Busy Call Forwarding function must be enabled in system programming.
- (2) The receiving telephone number can individually be registered for each master station (or telephone) in the system programming.

22.2. Registration and Cancellation

Use the original station to register or cancel this function.

22.2.1. Registration

First dial [*][6][5], and then the outside line access number (example: [0]) followed by [#].
Registration completion is indicated by a confirmation tone and the station is placed in standby mode.

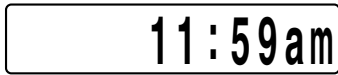

22.2.2. Cancellation

First dial [*][6][5], and then the original station number (example: [9][3]) followed by [#].
Cancellation completion is indicated by a confirmation tone. The current time is then displayed and the station returns to standby mode.



22.3. Outside Line Busy Call Forwarding Operation

Calls to a busy station (example: 92) are automatically forwarded to another designated telephone.

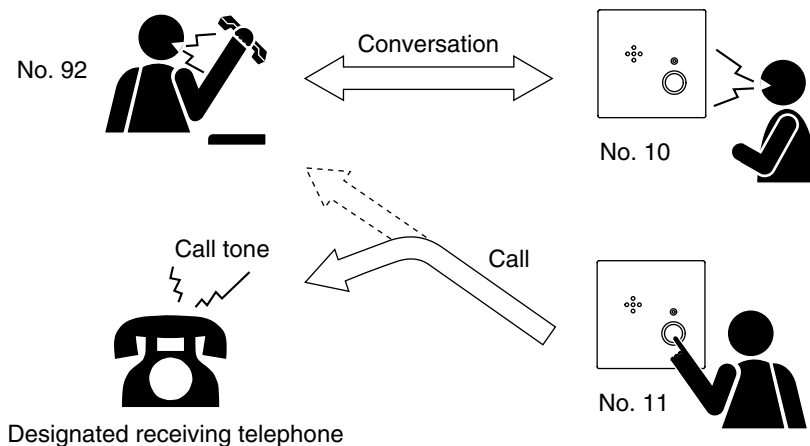

[[Exceptions]

- (1) The outside line telephone can directly call the original station without interference from this call forwarding function.
- (2) Calls are not transferred when a designated outside line telephone is also busy.
When either of the original station (example: 92) or the designated telephone becomes free, the calls are connected to the line.
- (3) The Outside Line Busy Call Forwarding function does not interfere with a substation call to a Group Call representative station that is registered for Outside Line Busy Call Forwarding. (The group call designation is given priority.)

CONFERENCE-RELATED FUNCTIONS

23. THREE-PARTY CONFERENCE (INDIVIDUAL CALL CONFERENCE)

23.1. Function

Any master station (or telephone) can individually call other master stations (telephones) to hold a 3-party conference.

23.2. Three-Party Conference Dialing Operation

23.2.1. Initiating a 3-party conference

Step 1. Dial [*][5] then the station number (example: [9][1]) of a second party.

When the second party answers, the conversation between the first and second parties can begin.

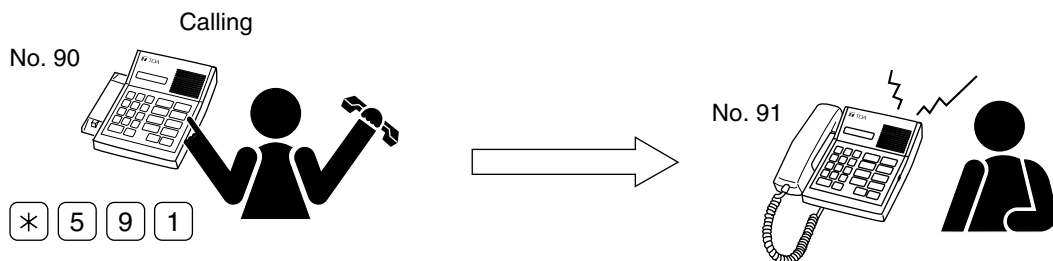

Step 2. Press the Transfer ([XFER]) key. (Press and release the telephone hook switch if the station is a telephone.)

The second party will then be placed on hold.

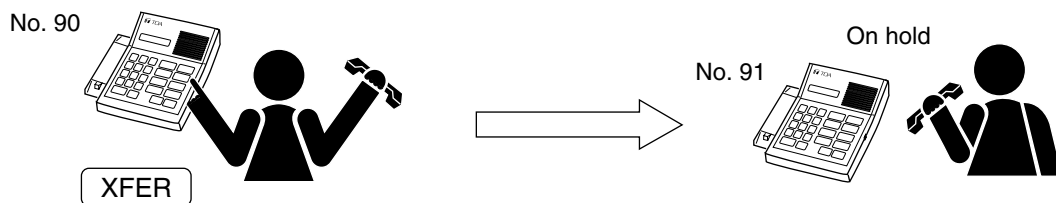

Step 3. Dial the station number (example: [9][2]) of a third party.
 When the third party answers, the second party is released from hold mode, permitting a 3-party conversation to proceed.

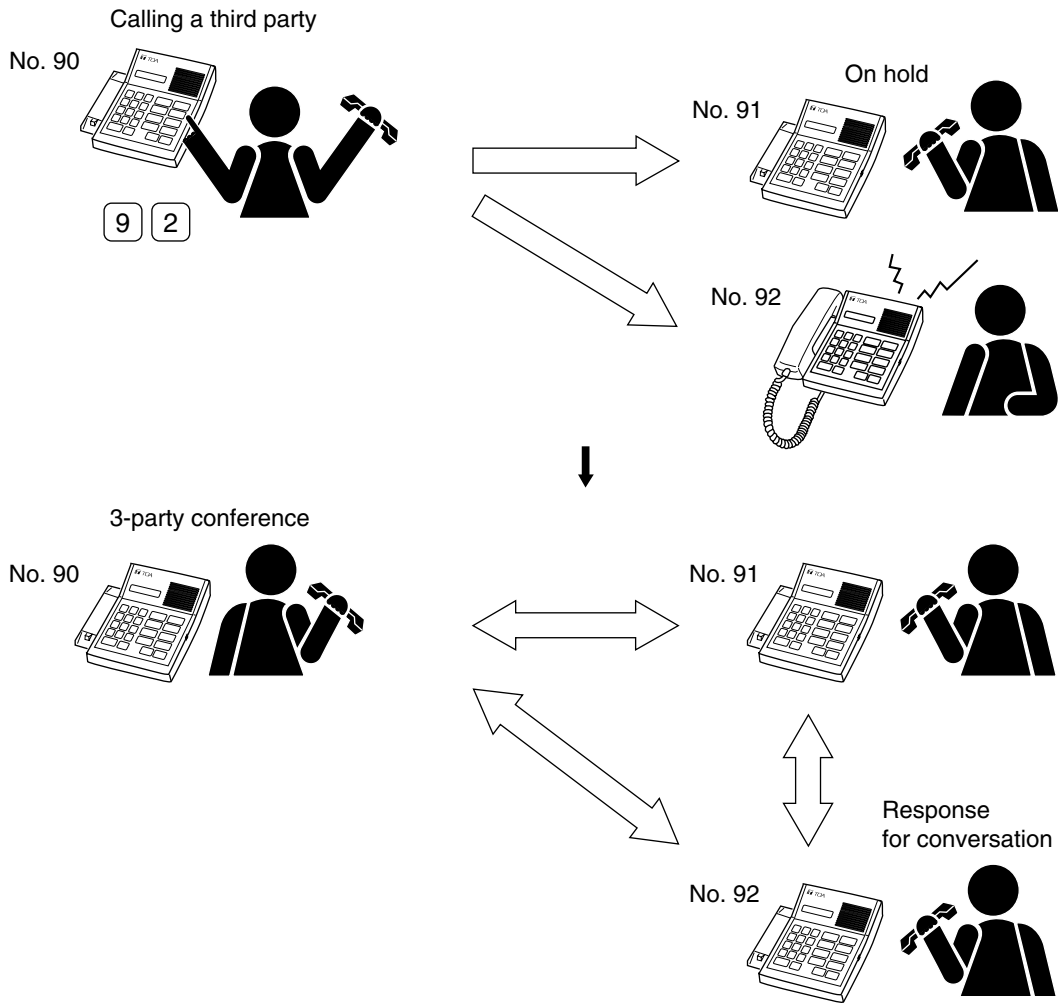

Step 4. The conference is terminated when the originating station either replaces the handset or presses the [C] key.

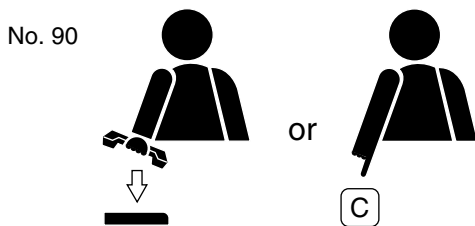

Stations other than the conference originating station can exit the conference by replacing the handset or pressing the [C] key.

Note: For operation details, refer to p. 3-32 "23.2.3. Operation details of 3-party conference."

23.2.2. Initiating a 3-party conference during a 2-party conversation

Step 1. While connected with a second party, press the Transfer ([XFER]) key (or press and release the telephone hook switch if the station is a telephone).
The second party will be placed on hold.

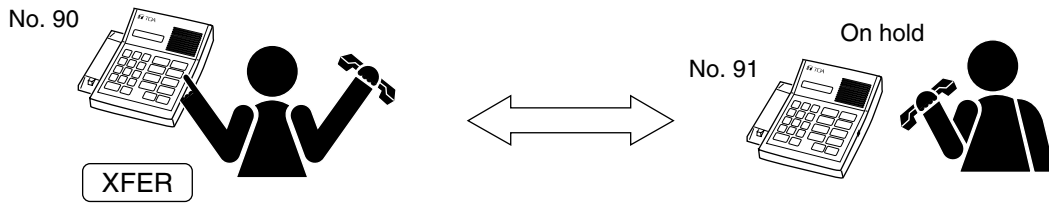

Step 2. Dial [*][5] followed by the station number (example: [9][2]) of a third party.
When the third party answers, the second party is released from hold mode, permitting a 3-party conference to proceed.

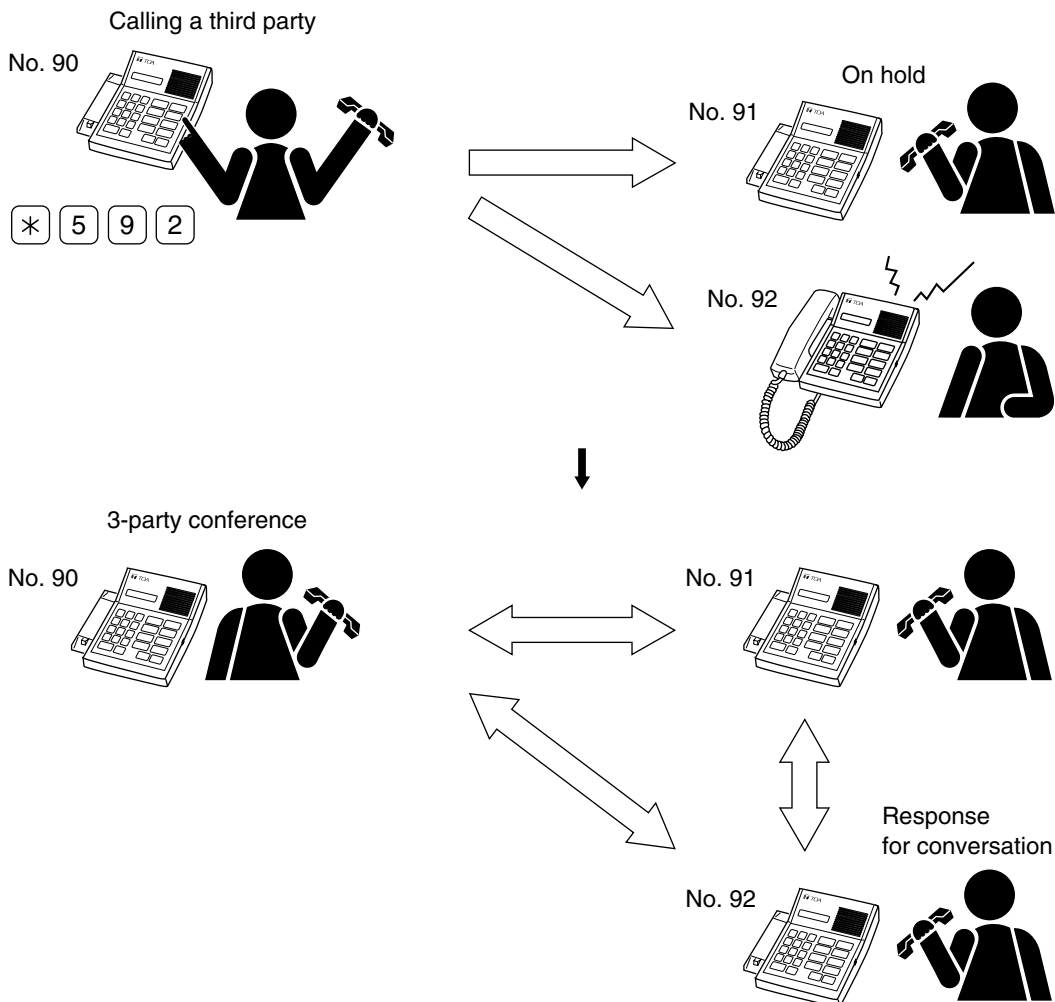

Step 3. The conference is terminated when the originating station either replaces the handset or presses the [C] key.

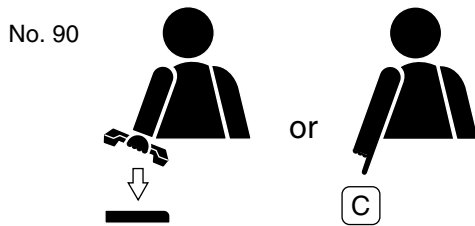

Stations other than the conference originating station can exit the conference by replacing the handset or pressing the [C] key.

23.2.3. Operation details of 3-party conference

- (1) When the called master station presses the [PTT] key to answer, the calling party's voice is heard from the station speaker (handsfree voice reception mode). Lift the handset to talk.
- (2) When the called master station or telephone is registered for Call Forwarding functions,
 - (a) the conference call is automatically forwarded if the designated receiving station is a master station or telephone.
 - (b) the conference call is not automatically forwarded if the designated receiving station is an outside line telephone.
- (3) A trunk busy tone sounds at the calling station and the original two-party conversation is restored if the conference trunk is occupied.
- (4) When the called third party is busy, a busy tone is transmitted to the calling party and the calling party must wait. As soon as the third party finishes its conversation, the calling party is automatically put through to the third party. (Camp-On Busy mode)
- (5) If the Call Back function is performed^{*1} while attempting to call a third party, the call is canceled, and the original conversation is restored^{*2}.

^{*1} By pressing the Transfer ([XFER]) key (or by pressing and releasing the telephone hook switch if the station is a telephone).

^{*2} Replacing the handset or pressing the [C] key during attempts to call a third party will terminate the original conversation.

24. EMERGENCY CONFERENCE

24.1. Function

To enable conferences among up to 4 parties in emergency situations, master stations or telephones can call other registered master stations or telephones with a simple operation.

[System pre-programming]

To use this function, up to 3 master stations or telephones must be individually assigned to each master station in the system programming.

24.2. Emergency Conference Dialing Operation

- Step 1.** Dial [#][#][#][#]. (The calling station becomes a conference originating station.)
Up to 3 registered master stations or telephones are then simultaneously called.
The called master stations are switched to handsfree voice reception mode after a brief calling tone even if they do not answer.

Notes

- (1) The called parties must lift the handset to talk. The [PTT] key cannot be used to talk.
- (2) When telephones are called, a call tone continuously sounds until the conference is entered by lifting the handset.

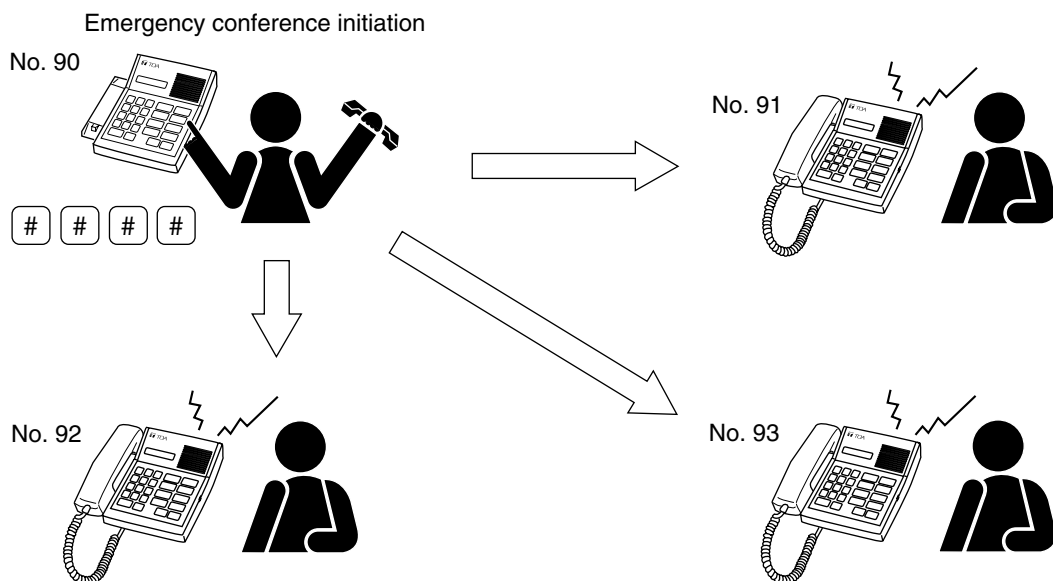

Step 2. The called master stations can enter the conference by lifting the handset.

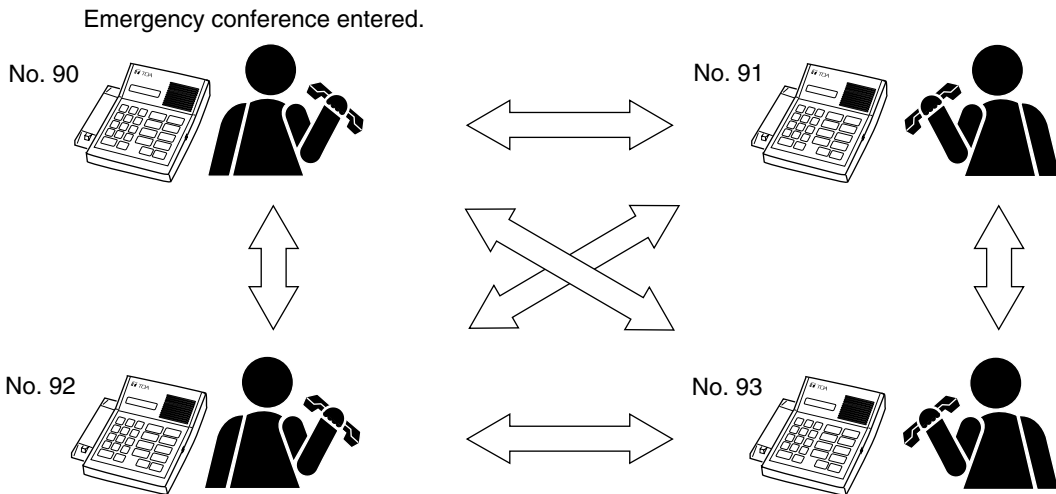

Step 3. The conference is terminated when the originating station either replaces the handset or presses the [C] key.

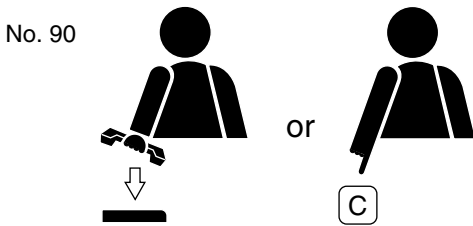

Stations other than the conference originating station can exit the conference by replacing the handset or pressing the [C] key.

[Function details]

When a conference trunk is used for Emergency Conference by other members, a trunk busy tone is sounded at the originating station and the originating station is restored to the normal standby mode.

CHAPTER 4. SUMMARY OF DIALING OPERATIONS AND PRIORITIES

1. MASTER STATION OPERATION TABLE

Function	Item	Operation	Remark
Call/response	Call	Dial the station number [X][X] ([X][X][X][X]).	Station No.: 2 – 6 digits
	Response	Either lift the handset or press [PTT].	
	Selective Response	Select the calling station using [REDIAL], then lift the handset. Select the calling station using [REDIAL], then press [PTT].	Telephones cannot be used.
Conversation	PTT (Press-To-Talk)	Press [PTT] to talk.	Telephones cannot be used.
	Conversation	Release [PTT] to listen.	
	Simultaneous Conversation	Either party or both parties lift the handset.	Between master stations
Speed Dialing	Auto Dialing	Press the Auto Dial key ([1] – [8]).	Telephones cannot be used.
	Redial	Press [REDIAL].	
Call Transfer	Call Transfer	Press [XFER] during a conversation. → Other party is placed on hold. Dial the station number to call a third party. → Conversation with the third party. (Call Hold) Either replace the handset or press [C]. → Transfer completed.	Cannot be transferred to a substation. (The Call Hold function remains operational.)
	Call Back	Press [XFER] during a conversation. → Other party is placed on hold. Dial the station number to call a third party. → Conversation with the third party. (Call Hold) Press [XFER] again. → Original conversation is resumed. (Call Back)	
Call Forwarding	Registration at Original Station	Dial [*][6][0][Transferred station No.][#].	Station No.: 2 – 6 digits
	Cancellation at Original Station	Dial [*][6][0][Original station No.][#].	
	Registration at Transferred Station	Dial [*][6][1][Original station No.][#].	
	Cancellation at Transferred Station	Dial [*][6][2][Original station No.][#].	
Time-Based Call Forwarding	Registration	Dial [*][6][3][Transferred station No.][#].	Station No.: 2 – 6 digits
	Cancellation	Dial [*][6][3][Original station No.][#].	
No-Answer Call Forwarding	Registration	Dial [*][6][4][Transferred station No.][#].	Station No.: 2 – 6 digits
	Cancellation	Dial [*][6][4][Original station No.][#].	
Busy Call Forwarding	Registration	Dial [*][6][5][Transferred station No.][#].	Station No.: 2 – 6 digits
	Cancellation	Dial [*][6][5][Original station No.][#].	
Scan Monitor	Start	Dial [*][2].	Dial while monitoring
	Stop/Re-start	Dial [0] to stop, and [0] again to re-start.	
	Scan Forward	Dial [#] to advance substation monitoring.	
	Scan Back	Dial [*] to reverse substation monitoring.	
	Voice Transmission	Press [PTT] to talk.	
	Termination	Either replace the handset or press [C].	
Paging	Zone Paging	Dial [*][8][Zone No.][Zone No.][Zone No.] ... [Zone No.][#]. (Up to 9 zones can be selected.)	[Zone No.]: 1 – 2 digits
	All-Zone Paging	Dial [*][8][0][0][#].	
	Emergency Paging	Dial [*][*][*][*].	
	Paging Redial	Dial [*][8][#].	
Outside Line	Call	Dial an outside line access No.	[Access No.]: 0 – 9
	Response	Lift the handset.	
Outside Line Call Forwarding	Registration	Dial [*][6][0][Access No.][#].	[Access No.]: 0 – 9
	Cancellation	Dial [*][6][0][Original station No.][#].	
Time-Based Outside Line Call Forwarding	Registration	Dial [*][6][3][Access No.][#].	[Access No.]: 0 – 9
	Cancellation	Dial [*][6][3][Original station No.][#].	
Outside Line No-Answer Call Forwarding	Registration	Dial [*][6][4][Access No.][#].	[Access No.]: 0 – 9
	Cancellation	Dial [*][6][4][Original station No.][#].	
Outside Line Busy Call Forwarding	Registration	Dial [*][6][5][Access No.][#].	[Access No.]: 0 – 9
	Cancellation	Dial [*][6][5][Original station No.][#].	
Conference	Three-Party Conference	Dial [*][5][Station No.]. → 2-party conversation	Station No.: 2 – 6 digits
		Dial [XFER][Station No.]. → 3-party conversation	
	Emergency Conference	Dial [XFER][*][5][Station No.] during a two-way conversation. → 3-party conversation	
	Emergency Conference	Dial [#][#][#][#].	4 master stations

2. PRIORITIES

The VS-900 system offers both Call Priority and Speech Path Priority operations.

(1) Call Priority

Determines the priority order of several calls made simultaneously to a master station or telephone.

(2) Speech Path Priority

Refers to the order of priority assigned to the exchange's speech path to enable higher priority conversation and call functions in the entire system. According to this priority order, conversations can be terminated or calls switched to waiting mode.

2.1. Call Priority

2.1.1. Call Priority and call tone (Calls to master stations)

Master stations differ from telephones in their method of processing the priority of multiple incoming calls. Shown below are priorities of calls made to master stations:

[Call Priority order]

1. Emergency Conference calls
2. Calls from Emergency substations
3. Calls from outside line telephone
4. Calls from Normal substations
5. Calls from master stations or telephones

[Call tone]

The following tone types are used for the above calls:

- (1) Emergency Conference call tone indicates an Emergency Conference call.
- (2) Emergency call tone indicates a call from an Emergency substation.
- (3) Outside line call tone indicates a call from an outside line telephone.
- (4) Normal call tone indicates a call from a Normal substation.
- (5) Master call tone indicates a call from a master station or telephone.

2.1.2. Call Priority (Calls to telephones)

- When several calls are simultaneously made to a telephone, the first received call is connected, while succeeding calls must wait in order of the above-described priority.
- Two different call tones are used to distinguish emergency calls from normal calls. The former features "continuous" sound and the latter "intermittent" sound.

2.1.3. Calls to substations

When several calls are simultaneously made to a substation, the first received call is connected, while succeeding calls must wait. Only one call tone is used.

2.2. Speech Path Priority

The order of priority assigned to the exchange's speech path to enable higher priority conversation and call functions in the entire system.

[Speech Path Priority order]

1. Emergency Paging
2. Emergency Conference
3. Outside line conversation
4. Calls from Emergency substations
5. External Source Distribution
6. All-Zone Paging
7. Zone paging
8. Normal conversation

The table below shows priority operations.

Speech Path Priority Matrix Table

Current status	Event (subsequent calls and broadcasts)				
	Emergency Paging	Emergency Conference (master station)	External Source Distribution	All-Zone Paging	Zone Paging
Emergency Paging	=	=	×	=	=
Emergency Conference (master station)	○	×	—	—	—
Outside line conversation	○	○	△	×	×
Emergency Substation call	○	○	△	×	×
External Source Distribution	○	○	×	×	×
All-Zone Paging	○	○	○	×	×
Zone Paging	○	○	○	○	×
Normal conversation	○	○	○	○	○

[=]: Access to the event is refused. (The event does not take place.)

[—]: Can be executed. (The event does not compete with the current broadcast.)

[△]: Can be executed except stations in competition. For excepted stations, the event is not executed even when the current conversation or broadcast is finished.)

[×]: The event is executed upon completion of the current conversation or broadcast.

[○]: Current conversation or broadcasts is terminated by the event.

CHAPTER 5. PC-CONTROLLED FUNCTIONS

1. THE ROLES OF PC INTERFACE SOFTWARE

Conversation and broadcasting functions described in Chapters 1 through 4 can only be used by programming individual line assignments for each facility, station numbering schedules, function details and other data into the exchange before the system is actually used. (Setting items necessary to enable each function are shown in the "System pre-programming" in each chapter.) To perform such settings, a personal computer loaded with dedicated software needs to be connected to the exchange. This dedicated software enables general control and maintenance settings as well as system programming functions.

Notes

- Some functions to be registered at master stations cannot be enabled without prior system programming.
- This chapter covers only the functions that require system programming. For their settings, refer to the "VS-900 SETUP SOFTWARE MANUAL."

2. SYSTEM PROGRAMMING (DATA SETTING)

2.1. System Setting

Setting Item	Contents
Number of Exchanges	Designates the number of exchanges to be used in the entire system (1 – 16).
Station Number Digit	Sets the digit length (2 – 6) to be used to label the system's station numbers.
Tie-Line Connections	Designates whether or not to use tie-line connection lines 1 – 4.
Exchange Station Number Assignment	Sets the first substation number to be connected each exchange. The station number range depends on the set station number digit length.

2.2. Line Setting

(1) Master station/telephone setting

Registers the following contents designating the exchange number (1 – 16 or ALL).

Setting Item	Contents
Station Number	Sets the station number. Each station number must be of the same digit length set in the System Setting.
Station Name	A name of up to 8 alphanumeric characters can be entered.
Access to Outgoing Calls	Sets whether or not each station is permitted access to the outside line.
Emergency Paging	Sets whether or not each station is permitted access to Emergency Paging.
"Outside Line Call Forwarding" Receiving Telephone Number	Sets the telephone number to which incoming calls are automatically rerouted. (Up to 20 digits in length)
"Call Forwarding" Receiving Station*	Sets the master station number or an outside line access number to receive calls in "Call Forwarding" mode. The station numbers connected to all exchanges can be programmed. The outside line access number must be identical to the number assigned to the corresponding exchange. It is also possible not to designate any receiving station.

Setting Item	Contents
"Time-Based Call Forwarding" Receiving Station*	Sets the master station number or an outside line access number to receive calls automatically forwarded while the system is in Time-Based Call Forwarding mode. The station numbers connected to all exchanges can be programmed. The outside line access number must be identical to the number assigned to the corresponding exchange. It is also possible not to designate any receiving station.
"Busy Call Forwarding" Receiving Station*	Sets the master station number or an outside line access number to receive calls automatically forwarded while the system is in Busy Call Forwarding mode. The station numbers connected to all exchanges can be programmed. The outside line access number must be identical to the number assigned to the corresponding exchange. It is also possible not to designate any receiving station.
"No-Answer Call Forwarding" Receiving Station*	Sets the master station number or an outside line access number to receive calls automatically forwarded while the system is in No-Answer Call Forwarding mode. The station numbers connected to all exchanges can be programmed. The outside line access number must be identical to the number assigned to the corresponding exchange. It is also possible not to designate any receiving station.

* This setting can be performed at the master station as well. Refer to the section describing each call forwarding function.

(2) Substation setting

Registers the following contents designating the exchange number (1 – 16 or ALL).

Setting Item	Contents
Station Number	Sets the station number within the range beginning at the selected exchange's first designated station number and ending at the number immediately preceding the next exchange's first station number. (Refer to the "System Setting.")
Station Name	A name of up to 8 alphanumeric characters can be entered.
Called Station Exchange Number	Sets the exchange number to which the called master station/telephone is connected.
Called Station Line Number	Sets the called master station/telephone line number.
Called Station Number	Sets the called master station/telephone number.
Called Station Name	Sets the called master station/telephone name.
Call Priority	Selects the call priority level: Normal or Emergency.

(3) Outside line setting

Registers the following contents designating the exchange number (1 – 16).

Setting Item	Contents
Outside Line Connection Time-Out	Enables/Disables the Outside Line Connection Time-Out function. Sets a time limit for telephone conversations (1 – 99 minutes).
Outside Line Name	Sets the name of the line.
Outgoing Call Access Number	Sets the access number for outgoing calls on the external line (0 – 9). Note that this setting is invalid for those stations designated as "receiving-only."
Direct-In Dialing	Selects this service.
Direct-In Line	Selects this service.
Receiving Station	When using the Direct-In line service, a receiving station group consisting of a representative station and 1 to 3 member stations is set. To set the stations, both the exchange and line numbers are designated for each master station (telephone).

2.3. Function Setting

(1) Group call setting

Registers the following contents designating the representative master station/telephone.

Setting Item	Contents
Member Station Exchange Number	Sets the exchange number (1 – 16) of the master station or telephone.
Member Station line Number	Sets the Line number (1 – 4) of the master station (telephone).

(2) Call forwarding & time-out settings

Registers the following contents designating the exchange number (1 – 16).

Setting Item	Contents
Call Forwarding	Enable/Disables the Call Forwarding function.
Time-Based Call Forwarding	Enables/Disables the Time-Based Call Forwarding function by its start and end times.
Time-Based Call Forwarding Start Time	Sets the hour and minute the call forwarding interval will begin. (00:00 – 23:59)
Time-Based Call Forwarding End Time	Sets the hour and minute the call forwarding interval will end. (00:00 – 23:59)
Busy Call Forwarding	Enables/Disables the Busy Call Forwarding function.
No-Answer Call forwarding	Enables/Disables the No-Answer Call forwarding function. If enabled, calls are transferred when no response is detected within the preset interval. Sets the station calling interval (1 – 99 seconds).
Call Time-Out	Enables/Disables the call time-out function. If enabled, calls are terminated when no response is made within the preset interval. Sets the station calling interval (1 – 99 minutes).
Conversation Time-Out	Enables/Disables the Conversation Time-Out function. If enabled, conversations are automatically terminated when the time limit is reached. Sets the conversation time limit (10 – 990 seconds).

(3) Scan monitor setting

Registers the following contents designating the master station.

Setting Item	Contents
Monitoring Time	Sets the scan-monitor time interval (1 – 99 seconds).
Monitoring Substation Exchange Number	Sets the number of the exchange to which the substation is connected (1 – 16).
Monitoring Substation Line Number	Sets the substation equipment number (1 – 64).
Monitoring Substation Number	Sets the substation number.
Monitoring Substation Name	Sets the substation name.

(4) Paging setting

Registers the substations assigned to the zone designating the exchange number (1 – 16).

Setting Item	Contents
Zone Number Digit	Selects the length of the digit to be used to label the paging zone numbers (1 – 2).
Paging Time-Out	Enables/Disables the Paging Time-Out function. Sets a Paging time limit (10 – 990 seconds).
Zone	Registers substation numbers (1 – 1024) for each zone.

(5) Public address system setting

Registers the control outputs assigned to the zone designating the exchange number (1 – 16).

Setting Item	Contents
Zone	Registers external public address equipment outputs (1 – 16) for each zone. Note Only 1 voice output is made available for paging to external equipment. It is impossible for 2 or more persons to simultaneously initiate paging.

(6) External source distribution setting

Registers zones to the control input designating the exchange number (1 – 16).

Setting Item	Contents
Zone	Registers up to 9 (19) paging zones for each activation input (1 – 4).

(7) Emergency conference setting

Registers the following contents designating the master station.

Setting Item	Contents
Member Station Exchange Number	Sets the exchange number to which the master station (telephone) is connected (1 – 16).
Member Station Line Number	Sets the line number of the master station (telephone) (1 – 4).
Member Station Number	Sets the station number of the master station (telephone).
Member Station Name	Sets the name of the master station (telephone).

(8) Direct select setting (Relay output from the VS-910DI card)

Registers the following contents designating the exchange number (1 – 16).

Setting Item	Contents
Control Output Mode	Selects the external equipment control output operation mode ("make contact" when conversation begins or when calls are initiated).

3. MAINTENANCE/CONTROL FUNCTIONS

Function	Contents
Remote Dialing	Dialing operations can be remotely performed from a PC instead of the master Station by designating the exchange and master station number.
Log Data	The operating log of each exchange can be read, printed out or stored on hard disk.
Upload/Download	Data can be transmit or received.
Print Out	The exchange setting contents are print out.
PC Port Setting	Setting are made for the connection method and COM port between PC and exchange.

4. VS-900DI SETTING

This function is registered when the VS-900DI card is used. For the functions to be registered, refer to the "VS-900DI/VS-910DI INSTRUCTION MANUAL."

