



TOA POWERED MIXER

Model MCX-106



TOA ELECTRIC CO., LTD.

KOBE, JAPAN

● Contents

General Description	2
Features	2
Front Panel [Input Section]	3
Front Panel [Output Section]	4
Front Panel [Stereo Cassette Recorder Section]	5
Front Panel [Patch Bay & Bus Link]	6
Rear Panel	6
Connection Examples	7
Input Connections	8
How to get a good mix	9
Recording Level Setting	9
Type of Cassette Tape	10
Maintenance of Stereo Cassette Deck	10
Block and Level Diagrams	11
Specifications	12 ~ 13
Characteristic Diagrams	13 ~ 14
Appearance	14

● Precautions

1. XLR Type Audio Connector

The connectors are wired as follows.

The pin 1 is ground (shield), the pin 2 cold (low, minus), the pin 3 hot (high, plus).

2. Description of components and functions on the MCX-106.

Descriptions may vary, depending on each manufacturer. In our Operating and Instruction Manual explanation of components and functions is made according to our usage for them.

● MCX-106™ Operating Guide

A Few Words about design:

The MCX™ is quite an unusual product, but the reasoning behind its design was quite simple we wanted to intergrate all the basic components of a sound reinforcement system and a recording studio into a single, transportable package.

The basic components of the MCX™ are as follows:

1. Six-channel main mixer.
2. Six-channel on-stage monitor mixer.
3. Six-channel special effects mixer.
4. Six-channel recording mixer.
5. Stereo tape deck.

6. One-octave equalizer.
7. Patch bay.
8. Headphone cue/monitor system.
9. Three-hundred watt power amplifier.
10. Road case.

Each of these "components" functions independently of the others, although some do share common signal processing and control circuitry. For example, the main mixer, effects mixer, and recording mixer all make use of the same input equalization on each of the six channels. And the input trim control performs the same function for all four mixing sections.

● General Description

The MCX-106 is a compact self-powered mixer with a Microprocessor controlled stereo cassette deck, designed to allow recording a live demo tape, performing to pre-recorded program material, recording sound on sound with an external tape source, and simultaneously performing as a six-channel "powered" main sound system and a six-channel independent monitor mixer.

The MCX-106 features: six input channels, a 300 watt power amplifier, 9-band graphic equalizer, automatic compressor, reverb effect, fluorescent bargraph meter, power amplifier protection circuitry, and a complete patch bay.

Each input channel features: input trim control with LED peak indicator, pre-EQ foldback send, 3-band EQ, post-EQ recording level and pan controls, post-reverb/effects send, Lo-Z balanced XLR input and Hi-Z unbalanced 1/4" input.

The built-in cassette deck features: full logic cassette mechanism control, dbx noise reduction system, zero return and cue functions, automatic tape selector.

All these unique functions are integrated into a ruggedly construct and portable package, offering unlimited applications for school, church, band, performing group, etc.

The MCX-106 is a "first of its kind" product, providing such a wide variety of versatility.

● Features

1. Built-in Stereo Cassette Recorder with micro-processor control
2. Six Input Channels
3. 300 watt Power Amplifier
4. 9-band Graphic Equalizer with Bypass Switch
5. Auto-Comp™ Compression Circuitry with LED indicator
6. Reverberation Effect with 2-band dedicated EQ
7. Fluorescent Bargraph Metering— assignable
8. Power Amp Protection Circuitry with indicator
9. Complete patch Bay with Buss-Link™
10. Aux. Input with Stereo Balance and Level Controls — assignable to PGM, FB, and Rec L & R Busses
11. Headphone Monitoring/Cueing System
12. Independent Stage Monitor (FB) Mix

Each Channel

1. Input Trim Control with LED peak indicator
2. Pre-EQ foldback send
3. 3-Band EQ
4. Post-EQ recording level and pan controls
5. Post reverb/effects send
6. Lo-Z Balanced XLR Input
7. Hi-Z Unbalanced 1/4" Input

Stereo Cassette Recorder

1. Full Logic Cassette Mechanism Control
2. dbx® Noise Reduction System
3. Automatic Tape Selector with Indicator (normal, CrO₂ Metal)
4. Headphone Output with Level Control
5. Tape Transport Remote Control (start/stop)
6. Tape Pitch Control (±10%)
7. Zero Return with Automatic Cue
8. 3-Digit Tape Counter

● Front Panel, Input Section

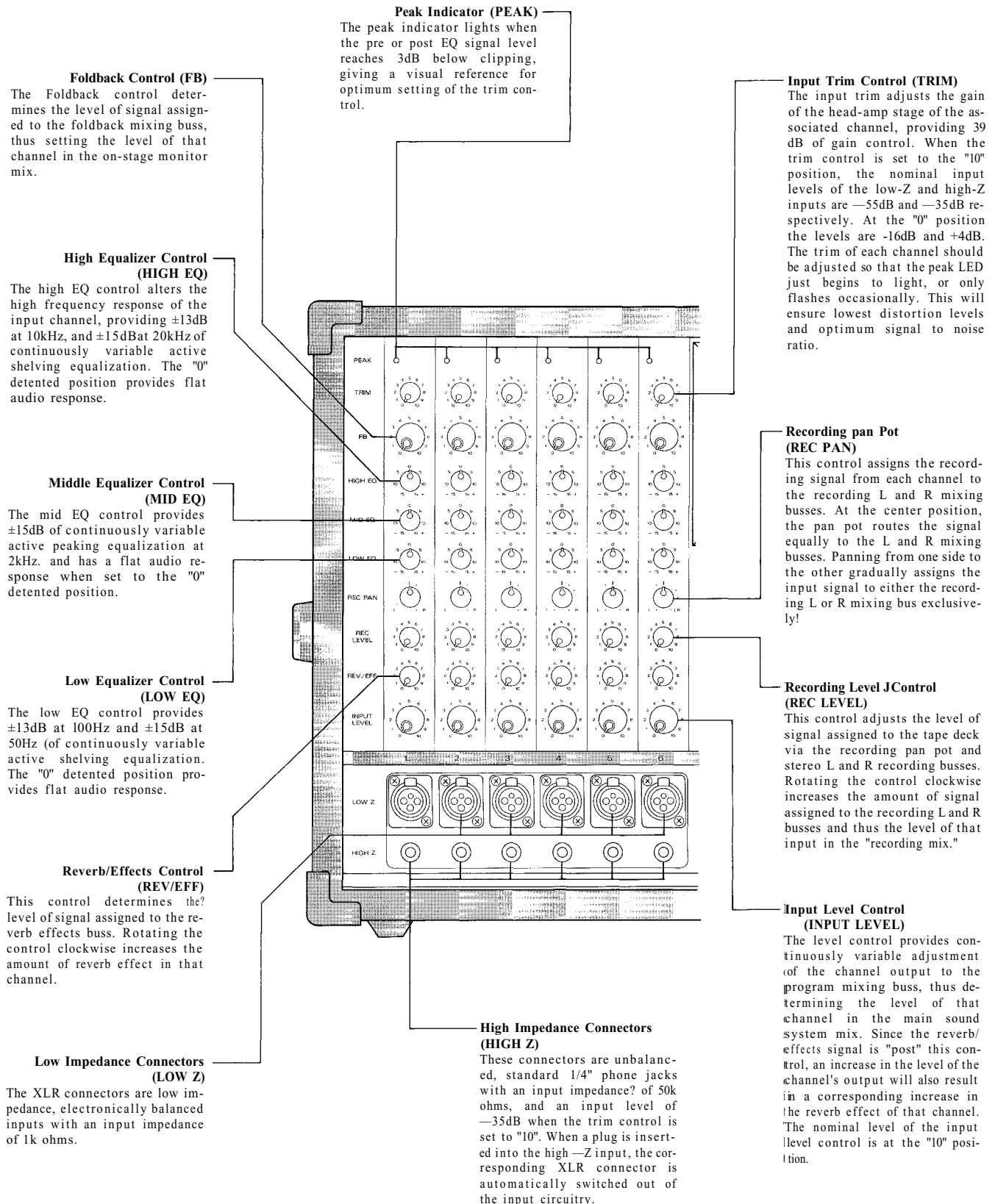

Front Panel, Output Section

Aux Recording Balance (AUX REC BAL)
This control adjusts the level balance of the aux in, L and R signals routed to the L and R mixing busses. At the center position, the balance control routes the signal equally to the L and R mixing busses.

Auxiliary Input Recording Level Control (AUX REC LEVEL)
This control sets the level of stereo L and R signal (from an external source connected to the AUX INPUT) assigned to the recording busses, via the AUX REC BAL control.

Auxiliary Input to Foldback Control ((AUX TO FB))
This control sets the level of aux input signal assigned to the foldback mixing bus, and thus the level of the external aux source in the on-stage monitor mix.
NOTE: If the aux source is a stereo L and R signal (for example, a stereo cassette player) the L and R will be combined into one mono signal before assignment to either the FB or PGM mixing busses.

Auxiliary Input to Program Control (AUX TO PGM)
This control sets the level of aux input signal assigned to the program mixing bus, and thus the level of the external aux source in the main mix.

Effect to Foldback Control (EFF TO FB)
This control determines the level of reverb/effects return signal assigned to the foldback mixing buss, and thus the amount of effects in the on-stage monitor mix.

Reverb/Effects to Program Control (EFF TO PGM)
This control adjusts the amount of reverb/effects signal that is returned to the program buss and thus the level of reverb/effects contained in the main sound system.

Reverb/Effects Send Control (REV/EFF SEND)
This control adjusts the overall signal level of the effects mix that is delivered to the internal reverberation unit, or to an external effects device through the effects output. The send control works in conjunction with the REV/EFF to PGM and the REV/EFF to FB controls to set the overall level of reverb/effects in the main and monitor sound systems.

Reverberation High Equalizer Control (REV HIGH EQ)
The high EQ control alters the high frequency response of the reverberation signal. The "0" detented position provides flat audio response.

Recording Level Control (EFF REC LEVEL)
This control sets the level of reverb (or external effects) in the recording mix, via the effects return pan pot.

Effect Recording Pan Control (EFF REC PAN)
This control assigns the reverb or external effects signal to the recording L and R mixing busses. In the center "detented" position, the signal is assigned equally to L and R; panning the control gradually assigns the effect to either bus exclusively.

Reverberation Low Equalizer Control (REV LOW EQ)
The low EQ control alters the low frequency response of the reverberation signal. The "0" detented position provides flat audio response.

Playback to Program Control (TAPE TO PGM)
This control adjusts the level of playback signal routed to the program mixing buss, and thus the level of the internal tape? source in the main mix.

Playback to Foldback Control (TAPE TO FB)
This control adjusts the level of playback signal to the foldback mixing buss, and thus the level of the internal tape in the on-stage monitor mix.

Foldback Master Control (FB)
The FB master control adjusts the overall combined signal level of the six independent channel foldback sends, and thus the level of the entire on-stage monitor mix.

Program Master Control (PGM)
The PGM control adjusts the overall combined signal level of the six independent channel level controls, and thus the level of the main sound system.

Graphic Equalizer (EQUALIZATION)
The graphic equalizer is 1/1 octave with 9 independent active bands (filters), providing 12dB of boost or cut at each center frequency. The "0" detented position provides flat audio response.

Graphic Equalizer In/Out Switch (IN/OUT)
The in/out switch enables comparison between a flat response (out) and the equalized response (in). The "out" position completely removes the equalizer from the MCX-106 circuitry.

Phones Level Control (PHONES)
The phones level control adjusts both the recording L and R signals fed to the phones output and permits recording and playback monitoring.

Headphone Jack
The headphone jack will accept any stereo headphone with 8 ohms impedance, or higher.

Tape Deck Remote Control (TAPE REMOTE)
This jack remotely operates the tape PAUSE function during recording or playback by means of a foot switch.

Power Amp Protection Indicator (PROTECT)
The indicator LED lights if the power amplifier output is shorted, if the temperature of the unit rises above acceptable levels, or if DG is drifted to the speaker outputs. If the LED should light, speaker wiring and ambient temperature of the MCX-106 should be checked. If the LED remains lighted, the unit should be referred to qualified service personnel for repair.
Note: The MCX-106 protection circuitry will (1) detect 'faulty conditions' within the power amplifier, (2) give a visual indication, and (3) automatically shut down until the; fault condition is alleviated. This special circuitry ensures maximum reliability and virtually eliminates equipment damage due to unsafe or fault conditions. Please refer to fault protection table on page 9 for full explanation of this important feature.

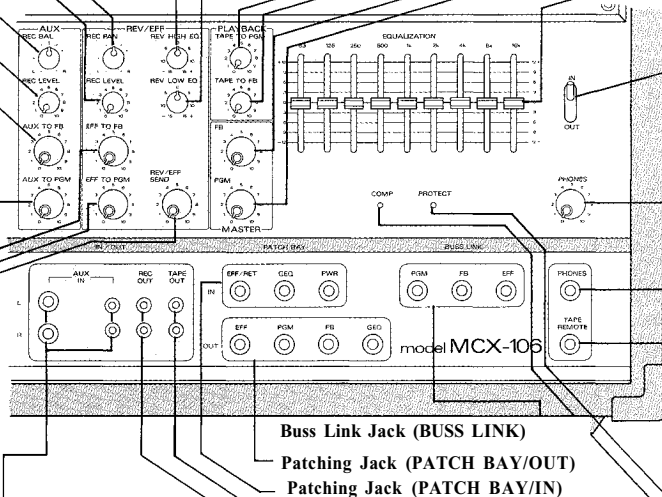

Aux Input L and R (AUX IN, L, R)
The aux L and R 1/4" phone jacks are unbalanced and accept low and high impedance sources at nominal -20 dB level. The jacks are wired with the corresponding L and R pin jacks in parallel. When a plug is inserted in the phone jack, the pin jack is automatically switched out of the aux input circuitry. The aux input is intended primarily for external music sources such as cassette tape players, radio receivers, or record players.
NOTE: A phonograph with magnetic cartridge requires the use of a pre-amp with RIAA equalization.

Recording Output Pin Jack (REC OUT)
The REC out pin jack derives its signal from the recording L and R mixing busses, and is intended for connection to external recording equipment. Nominal output level is -10 dB with an impedance of 1k ohms.

Playback Output Pin Jack (TAPE OUT)
The playback out pin jack obtains its signal from the internal tape deck. Nominal output level is 0dB dB with an impedance of 1k ohms.

Power Amp Compression-Indicator (COMP)
The comp LED lights when the internal compressor is activated. The compressor is provided to protect speaker systems by compressing the input signal level of the power amplifier when clipping occurs in the output stage. Frequent flashing of the LED is not reason for alarm. However, a constant or steady light indicates that the MCX-106 is being overdriven and that the internal power amplifier is possibly "under powered" (or that application. The output level of the; MCX-106 should be decreased until the LED only flashes intermittently.

Front Panel Stereo Cassette Deck Section

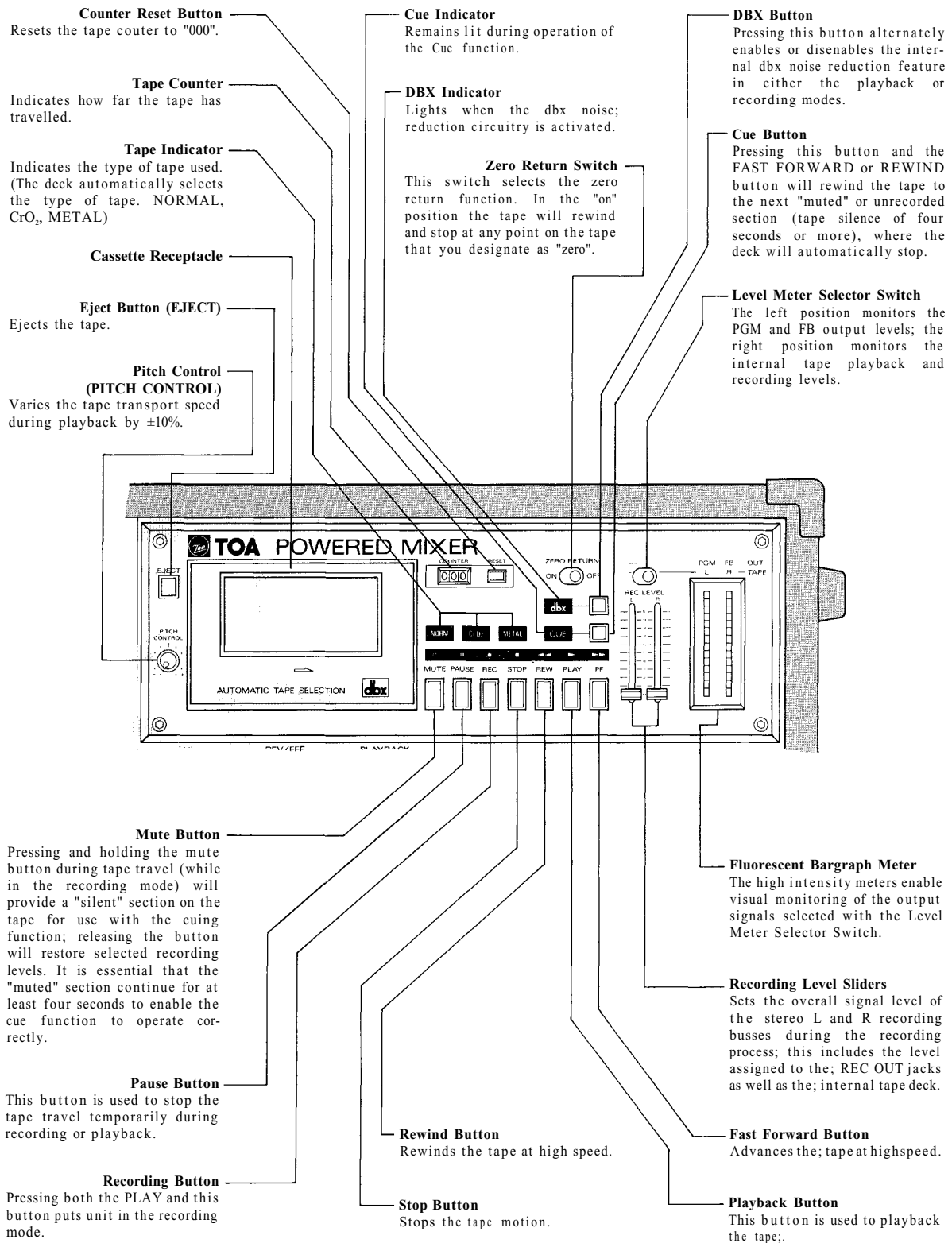

● Front Panel, Patch Bay & Buss Link

Effects Return Jack (EFT/RET)

The EFF/RET jack is provided to connect an external effects device to the MCX-106. When a plug is inserted the internal reverberation unit is automatically switched out of the MCX-106 circuitry, being replaced by the external unit. This jack should be connected to the output of the external effects unit. Nominal input level is -20dB with an impedance of 50k ohms .

Effects Output Jack (EFF)

The EFF Out jack used in conjunction with the EFF/RET Jack allows use of an external effects device in place of the internal reverberation unit. The effects out jack should be connected to the input of the external effect unit. Nominal output level is -10dB with an impedance of 600 ohms .

Program Output Jack (PGM)

The PGM Out jack is provided for connection to external equalizers and/or power amps, deriving its signal prior to the internal GEQ and power amp. Nominal output level is $+4\text{dB}$ with an impedance of 600 ohms .

Graphic Equalizer Input Jack (GEQ)

The GEQ input jack allows the graphic equalizer to be used independently of the MCX-106 with other external equipment, or the internal power amplifier and the graphic equalizer with external equipment. When a plug is inserted, the main mix from the program buss is disconnected from the graphic equalizer and the power amplifier. The nominal input level is -4dB with an input impedance of 50k ohms .

Power Amplifier Input Jack (PWR)

The PWR Amp input jack allows the internal power amplifier to be used with external equipment. When a plug is inserted, the power amp is automatically disconnected from the MCX-106 mixer section. The nominal input level is $+4\text{dB}$ with an input impedance of 10k ohms .

Program Buss Link Jack (PGM) (+4dB 22k Ω)

Fold Back Buss Link (FB) (+4dB 22k Ω)

Reverb/Effects Buss Link Jack (EFF) (+4dB 22k Ω) Buss Link Jacks

The buss link provides direct access to the PGM, FB, and effects mixing busses, and is provided for easy input expansion with additional MCX-106 units or other auxiliary equipment. All jacks have an input level of $+4\text{dB}$ with an impedance of 22k ohms .

Foldback Output Jack (FB)

This jack is for connection to external power amplifiers and/or equalizers for the on-stage monitoring system. Nominal output level is $+4\text{dB}$ with an impedance of 600 ohms . If the internal power amp and equalizer are to be used for the on-stage monitor system, the FB output should be connected to the GEQ input jack.

Graphic Equalizer Output Jack (GEQ)

This jack allows the MCX-106 and the internal graphic equalizer to be used with an external power amplifier, or in conjunction with the GEQ in jack, to be used independently of all other MCX-106 circuitry. Nominal output level is $+4\text{dB}$ with an impedance of 600 ohms .

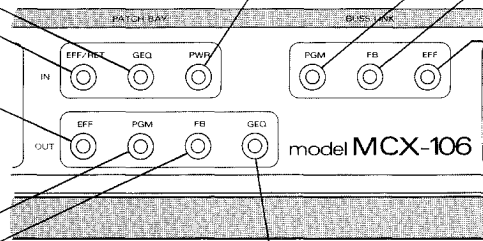

● Rear Panel

Power Switch (POWER)

The power switch is a three-position type with the middle position being the "off" position. The MCX-106 should be operated in the switch position which produces the lowest amount of system hum.

Speaker Jacks (SPEAKERS)

The speaker outputs are standard $1/4"$ phone jacks wired in parallel. Speaker cables (recommend at least #18 gauge wire) should be connected between the MCX-106 and the speaker systems prior to applying power to the unit.

Caution - The MCX-106 should never be operated into less than a 2 ohm speaker load.

AC Power Cord

The power cord is the three-wire type with proper grounding facilities.

Caution - The ground pin should not be removed under any circumstances. If the MCX-106 must be used without proper grounding facilities, a suitable grounding adapter should be

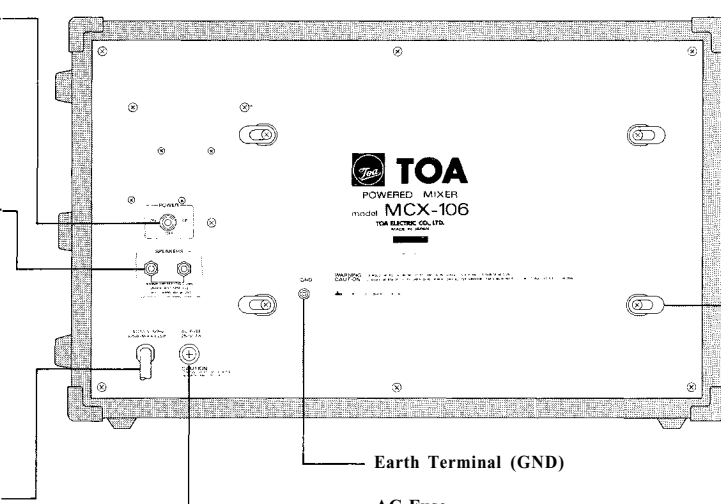

Cord Wrap

The cord wrap is provided for convenient storage of the power cord when the MCX-106 is not in use.

Caution - The power cord should always be completely removed from the cord wrap prior to operation of the unit. This will insure maximum cooling of the MCX-106. For the same reason, adequate clearance should be maintained between the rear panel and any other surface (4-6 inches should do). The vents on the bottom and top of the MCX-106 are also provided for convection cooling. These vents should be kept clear and open. Failure to do so may cause thermal shutdown of the unit.

utilized. Operation of the MCX-106 with proper grounding techniques will result in less system noise and greatly reduced shock hazard.

Warning - To avoid possible equipment damage and or personnel injury, the fuse should always be replaced with same type and rating. Using improper fuses will also void the warran-

ty. The MCX-106 should always be disconnected from AC outlet prior to changing fuses. If fuse repeatedly fails, the unit should be referred to qualified service personnel for repair.

● Connection Examples

Low Z input should be connected with low impedance (50 ohm ~ 600 ohm) microphones

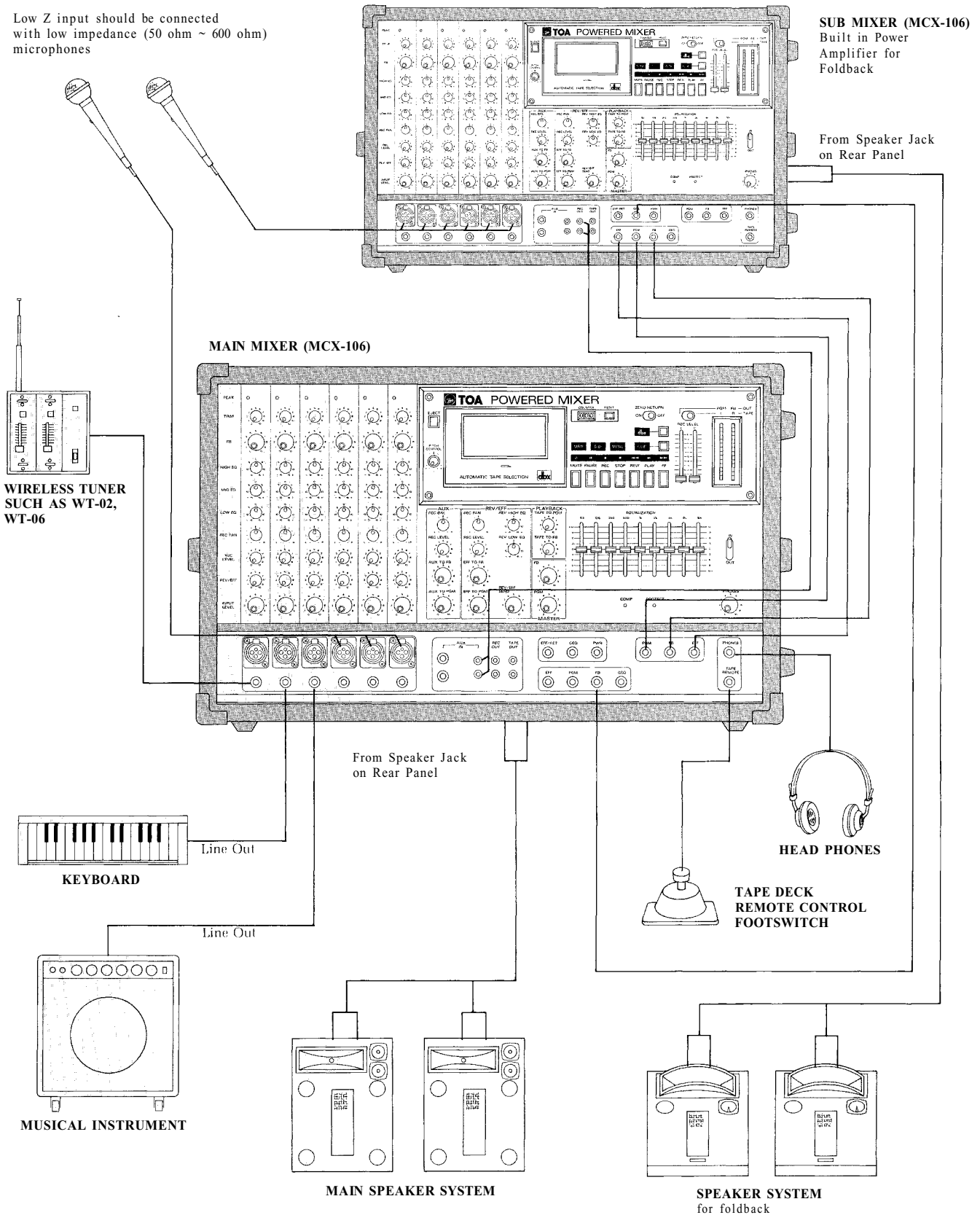

Input Connections

Generally speaking, there are two rules to follow when connecting equipment outputs to the inputs of other equipment.

1. Properly match the impedances of the outputs and inputs.
2. Connect low impedance outputs to high impedance inputs.

It goes without saying that not only input and output impedance matching but also level matching should be taken into consideration. Each input channel of the MCX-106 is provided with an input TRIM control, so the usable signal level range is very wide. Input impedances and levels are shown in the following table.

INPUT SPECIFICATIONS

CONNECTION	INPUT	ACTUAL LOAD IMPEDANCE	FOR USE WITH NOMINAL	TRIM POSITION	SENSITIVITY (PGM OUTPUT LEVEL +4dB)	MAX BEFORE CLIP INPUT LEVEL	CONNECTOR
CH1 ?	LOW Z	OPEN	50Ω TO 250Ω MICRO-PHONES	10	-55dBm (1.38mV)	-34dBm (15mV)	XLR TYPE NC3F
				0	-16dBm (123mV)	+1.7dB (0.94V)	
CH6	HIGH Z	50kΩ	50kΩ OR LOWER IMP LINES	10	-35dBm (13.8mV)	-14dBm (150mV)	PHONE JACK
				0	+4dBm (1.23mV)	+20dB (7.75V)	
AUX (L & R)	—	10kΩ	10kΩ OR LOWER IMP, LINES	—	-10dBm (245mV)	+8dBm (1.9V)	PHONE JACK RCA PIN JACK
EFF/RET	—	50kΩ	50kΩ OR LOWER IMP, LINES	—	-20dBm (77.5mV)	-2dBm (0.61V)	PHONE JACK
GEQ	—	50kΩ	50kΩ OR LOWER IMP, LINES	—	+4dBm (1.23V)	—	PHONE JACK
PWR	—	10kΩ	10kΩ OR LOWER IMP LINES	—	+4dBm (1.23V)	—	PHONE JACK
BUSS LINK (PGM, FB, EFF)	—	22kΩ	22kΩ OR LOWER IMP LINES	—	+4dBm (1.23V)	+20 dBm (7.75V)	PHONE JACK

*Sensitivity is the level required to produce a program out level of +4dBm.

*0dBm is referenced to 0.775V RMS.

All XLR Type connectors are electronically balanced (transformer less). Phone jack is unbalanced.

If the line going from one piece of equipment to another is long (more than 5m), we recommend that balanced outputs be connected to balanced inputs.

As is described in the beginning of the Operating Instructions Manual, the connectors of the MCX-106 are wired as follows: Pin 1 is ground (shield). Pin 2 is cold (low, minus). Pin 3 is hot (high, plus).

● How to get a good mix

Before connecting other equipment to the Powered mixer, check the impedance and level of both. If the impedances and levels do not match, mixing will be very difficult and the S/N ratio will also be adversely affected.

Each input channel of the MCX-106 is provided with a TRIM control. Thorough understanding of the function of a TRIM control will make mixing easier.

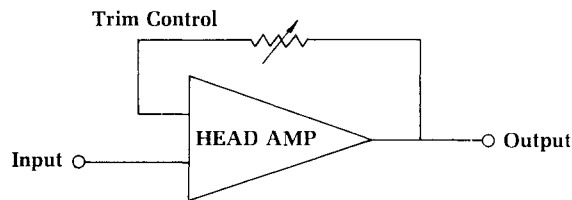

The function of the TRIM control is to control the negative feedback volume of the head-amp so that the gain of the head-amp can also be changed. Because of this, enough dynamic range, even for high level signals is ensured. Also, the S/N ratio will be better by decreasing the gain of the head-amp.

For example, a keyboard, a musical instrument and a dynamic microphone with output levels of -10dBm , -20dBm and -40dBm respectively are connected to the MCX-106.

If the trim control is set as shown in the left figure, the input level controls can be set to the same position.

The input level controls are used in general between 6 and 8.

The peak indicator LED illuminates if the head amplifier or equalizer is clipping. The gain of the head-amplifier must be decreased by turning the trim control counter-clockwise.

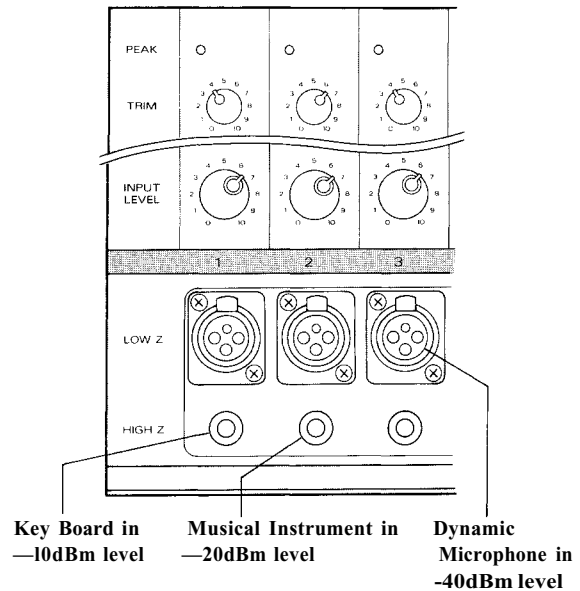

Fault Protection Table

Fault	Protection	Indication	Action	Restoration
Excessive current due to overloads.	Current limiter activates at less than 1 ohm.	Compressor LED illuminates.	Remove excessive loads. Minimum speaker loads 2-ohm.	Automatic restoration after normal loads are obtained.
Short circuits (less than 0.4-ohm)	Current limiter activates, input signal is lowered, unit shuts down.	Amp protection LED illuminates.	Check speaker lines/systems for shorts.	Turn off power switch. Turn on into operational loads.
Temperature rise of heat sink (more than 105°C)	Input signal is lowered. Unit shuts down.	Amp protection LED illuminates.	Check for adequate ventilation.	Automatic restoration after temperature lowers (to $75^{\circ} - 95^{\circ}\text{C}$)
DC drift	Input signal is lowered. Unit shuts down.	Amp protection LED illuminates.	Refer to qualified service personnel.	Automatic restoration after normal bias is regained.

● Recording Level Setting

The following procedures are recommended for an accurate and high-quality recording.

1. Place the level meter selection switch in the "Tape" position.
2. Engage the noise reduction circuitry by pressing the dbx switch.

NOTE:

Using the internal dbx circuitry will provide higher quality recordings with excellent "signal-to-noise" characteristics. You will notice a drastic reduction in audible "tape hiss" and a significant increase in dynamic range. However, the dbx noise reduction is

an "encode/decode" process, meaning that any tape that is recorded with dbx must also be played back with dbx, to obtain satisfactory results. If the recording must be played on other equipment without dbx circuitry, we recommend that the dbx feature not be used.

3. Press the record button to place the deck in "record pause" mode.
4. Adjust the L and R master recording level sliders to a level just below the "red" in the bargraph meters.
5. Press PLAY button to begin recording.

Types of Cassette Tape

Types of cassette tape

micron: 1/1000mm

Type	C-30	C-46	C-60	C-90	C-120
Tape travel hour	30 min.	46 min.	60 min.	90 min.	120 min.
Tape thickness	18 micron	18 micron	18 micron	12 micron	9 micron

CAUTION:

A C-120 tape is so thin that it can be easily stretched, causing tape slack and possible entanglement around the pinch roller and capstan. We do not recommend the use of C-120 cassette tapes.

NOTE:

The MCX detects the type of tape (Normal, CrO₂, Metal) when the cassette is inserted and the door is latched, automatically selects the proper EQ and bias settings, and gives a visual indication on the front panel.

For highest quality recordings and extended dynamic range, we recommend the use of metal tape whenever possible.

SAVING YOUR RECORDINGS

Cassette tapes are provided with two break-out tabs as shown in figure. To prevent accidental erasure or

overtaping, break the tabs with a screw-driver or similar tool and remove. You may cover the tab

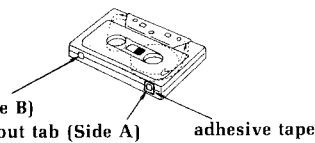

openings with adhesive tape if you desire to erase or record the tape at a later date.

Hints on Cassette Tape Handling

1. Tape Slack can cause the tape to twist or break. When necessary, always take up slack by inserting a pencil or similar object into the reel hub and turning.
2. Winding the tape too tightly on the reel may cause the tape to rotate unevenly; in worst case, the tape may bind and not wind from reel to reel. Before using a tape again after continuous playback or recording, lightly tap the cassette housing or both sides, and if necessary, rewind the tape in either the fast-forward or re-wind mode.

Storing Tapes

Always store cassette tapes in their cases with a protective insert over the exposed portion of the tape; if not available, attach a "stopper" made from paper as

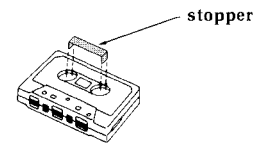

shown in the illustration. To prevent damage or degradation of recordings, always store tapes in locations free from direct sunlight, high temperature or humidity, and magnetic effects from other electrical equipment, speaker systems, etc.

Maintenance of Stereo Cassette Mechanism

Cleaning the tape heads

NOTE:

We recommend removal of the cassette receptacle door prior to the cleaning operation; this will facilitate easy access to all the inner workings of the tape transport assembly.

1. The cassette door opens when the EJECT button is pushed. After opening, press the door downward (see illustration) to disconnect the "top mounted

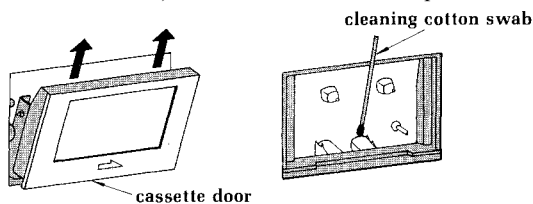

detents" which hold the door to the chassis. Now pull outward and away from the main assembly. Place the door aside in a safe location for later cleaning.

CAUTION:

To prevent damage to the transport and head assembly, use only cotton swabs or a soft cloth for the cleaning procedure.

2. Using any good grade of commercially available tape cleaning fluid (or an acceptable substitute such as alcohol), thoroughly clean the tape heads, tape guides, and all other metal parts in the tape path.

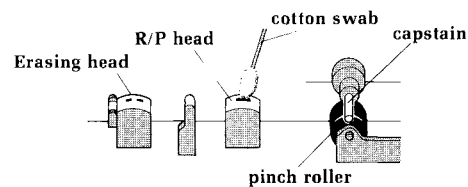

3. Clean the rubber parts of the transport assembly with cleaning fluid, or alcohol, and wipe dry with a clean, soft cloth.

NOTE:

If a transport "Lubricant" of any kind is used on the metal parts, take care to avoid contact with rubber parts.

CAUTION:

The tape heads and guides are carefully adjusted to ensure smooth and accurate tape travel during both recording and play back; DO NOT USE EXCESSIVE FORCE when cleaning; misalignment may result.

We recommend through cleaning of the tape transport assembly after every four to six hours of use to ensure optimum recording and play back performance.

Demagnetizing the tape heads

The recording head will become "magnetized" after prolonged use. This residual magnetism will degrade and possibly destroy your valuable recordings by adding unwanted noise and distortion, so it is necessary to frequently "demagnetize" the heads. There are many inexpensive head demagnetizers available; follow the manufacturer's directions for use.

Block and Level Diagrams

BLOCK DIAGRAMS

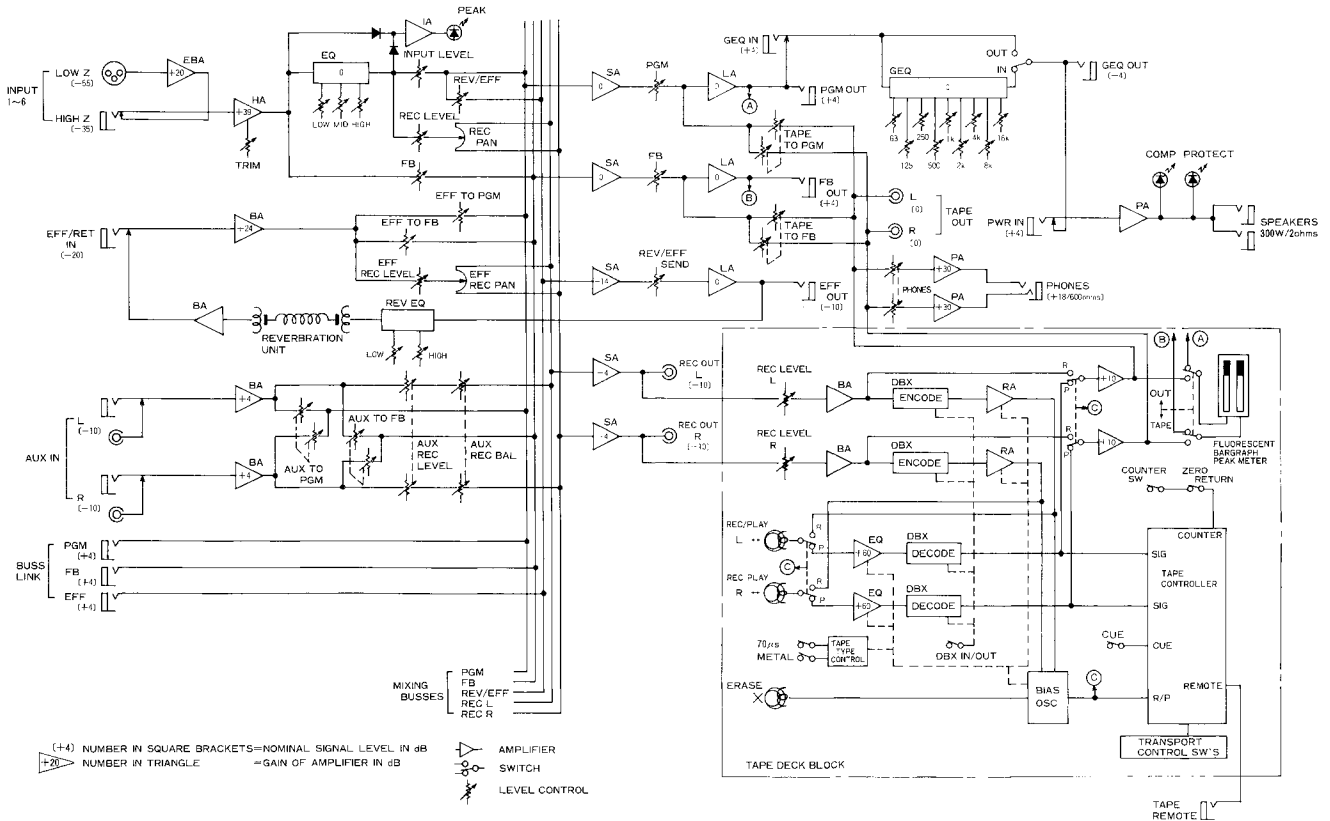

LEVEL DIAGRAM

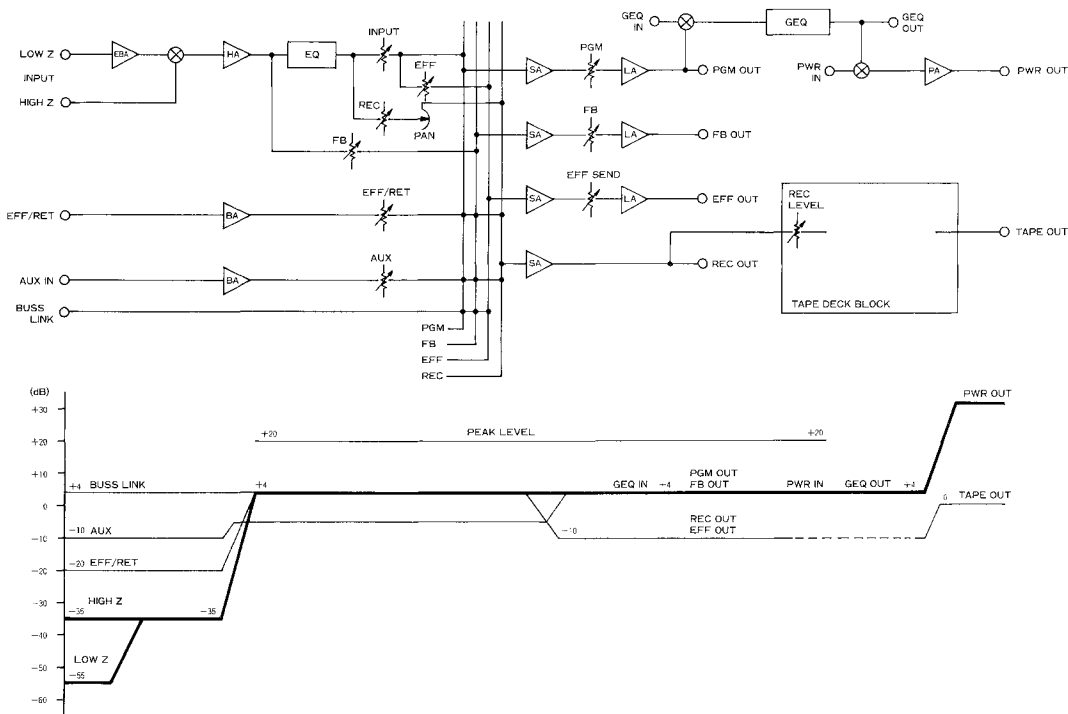

Specifications

MIXER SECTION

Frequency Response

+0, -3dB 30Hz~20kHz (HIGH Z input TRIM at "0" position.)

Total Harmonic Distortion

0.05% +4dBm at 1kHz.

Hum and Noise (Open)

Equivalent Input Noise -130dBm (20Hz~20kHz)
 Equivalent Input Noise -133dBm (IHF A)
 All level Controls Minimum -102dBm (IHF A)
 PGM Master at MAX and all input level controls minimum -93dBm (IHF A)
 PGM Master at MAX and one input level control at MAX -72dBm (IHF A)

Maximum Voltage Gain

INPUT to PGM out 59dB
 INPUT to EFF out 45dB
 INPUT to FB out 59dB
 INPUT to REC out 45dB
 INPUT to GEQ out 59dB
 AUX to PGM out 14dB
 EFF/RET to PGM out 24dB

Equalization

63Hz ±12dB Peaking 2kHz ±12dB Peaking
 125Hz ±12dB Peaking 4kHz ±12dB Peaking
 250kHz ±12dB Peaking 8kHz ±12dB Peaking
 500Hz ±12dB Peaking 16kHz ±12dB Peaking
 1kHz ±12dB Peaking

Peak Indicators

Red LED on each input channel LED's turn on at 3dB below clipping.

INPUT SPECIFICATIONS

CONNECTION	INPUT	ACTUAL LOAD IMPEDANCE	FOR USE WITH NOMINAL	TRIM POSITION	SENSITIVITY (PGM OUTPUT LEVEL +4dB)	MAX BEFORE CLIP INPUT LEVEL	CONNECTOR
CH1 ∧	LOW Z	OPEN	50Ω TO 250Ω MICRO-PHONES	10	-55dBm (1.38mV)	-34dBm (15mV)	XLR TYPE NC3F
				0	-16dBm (123mV)	+1.7dB (0.94V)	
CH6	HIGH Z	50kΩ	50kΩ OR LOWER IMP LINES	10	-35dBm (13.8mV)	-14dBm (150mV)	PHONE JACK
				0	+4dBm (1.23mV)	+20dB (7.75V)	
AUX (L & R)		10kΩ	10kΩ OR LOWER IMP, LINES		-10dBm (245mV)	+8dBm (1.9V)	PHONE JACK RCA PIN JACK
EFF/RET		50kΩ	50kΩ OR LOWER IMP, LINES		-20dBm (77.5mV)	-2dBm (0.61V)	PHONE JACK
GEQ		50kΩ	50kΩ OR LOWER IMP, LINES		+4dBm (1.23V)		PHONE JACK
PWR		10kΩ	10kΩ OR LOWER IMP LINES		+4dBm (1.23V)		PHONE JACK
BUSS LINK (PGM, FB, EFF)		22kΩ	22kΩ OR LOWER IMP LINES		+4dBm (1.23V)	+20 dBm (7.75V)	PHONE JACK

OUTPUT SPECIFICATIONS

CONNECTION	ACTUAL LOAD IMPEDANCE	FOR USE WITH NOMINAL	OUTPUT LEVEL		CONNECTOR
			NOMINAL	MAX. BEFORE CLIP	
PGM	600Ω	600Ω OR HIGHER IMP. LINES	+4dB (1.23V)	+20dB (7.75V)	PHONE JACK
EFF	600Ω	600Ω OR HIGHER IMP. LINES	+10dB (245V)	+8dB (1.9V)	PHONE JACK
GEQ	600Ω	600Ω OR HIGHER IMP. LINES	+4dB (1.23V)	+20dB (7.75V)	PHONE JACK
FB	600Ω	600Ω OR HIGHER IMP. LINES	+4dB (1.23V)	+20dB (7.75V)	PHONE JACK
REC L & R	1kΩ	1kΩ OR HIGHER IMP. LINES	-10dB (7.75V)	+8dB (1.9V)	RCA PIN JACK
TAPE L & R	100Ω	10kΩ OR HIGHER IMP. LINES	0dB (0.775V)	+20dB (7.75V)	RCA PIN JACK

POWER AMPLIFIER SECTION

Frequency Response

+0, -1dB 5Hz to 40kHz (200W RMS 4Ω)

Rated Power & Load

300W RMS (2Ω) 200W RMS (4Ω) 120W RMS (8Ω)

Power Output at Clipping

1% THD, 1kHz
 348W RMS (2Ω) 238W RMS (4Ω) 140W RMS (8Ω)

Total Harmonic Distortion

Less than 0.1% (200mW~200W RMS, 20Hz~20kHz)
 Typically below 0.05%

Compressor Dynamic Range

Greater than 26dB

Hum and Noise

At least 110dB S/N ratio, 20Hz~20kHz
 At least 113dB S/N ratio IHF-A weighted

Damping Factor

Greater than 200 (1kHz 4Ω)

Input Sensitivity

+4dBm (1.23V)

Input Impedance

10kΩ

Output Connector

Phone Jack X2

Power Requirement

600 W 120V AC 50/60Hz

Dimensions (WXHxD)

605X371X356mm (23.8X14.6 X14.0) inch

Weight

27.2 kg (60 lbs)

*0dBm is referenced to 0.775V RMS.

Specifications are subject to change without notice.

Specifications

STEREO CASSETTE DECK SECTION

Mechanism

1 Motor 3 Solenoid Mechanism

Control

4 Bit Micro Computer

Tape

Compact Cassette C-30, C-46, C-60 or C90

Track Format

4-Track, 2-Channel (Stereo)

Heads

2 Channel Stereo Recording/Play Back (Permalloy)

Erase (Ferrite Double Gap)

Tape Speed

1-7/8 ips (4.75 cm/s)±1%

Pitch Control

±10% of normal Tape Speed (Play Back Only)

Wow & Flutter

Less Than 0.08% RMS NAB Weighted

Fast Wind Time

Less Than 100 seconds (C-60 Tape)

Motor

Electronically Governor

Frequency Response

40 Hz to 12.5 kHz (Metal) (Overall Record/Playback)

Noise Reduction

*DBX type II (IN/OUT Switchable)

Signal to Noise Ratio

70dB *DBX IN 20 Hz~20 kHz

90 dB *DBX IN IHF-A Weighted

Total Harmonic Distortion

Less Than 3% at 1kHz 0dB

Bias Frequency

85kHz

Erasure

70 dB at 1kHz

*DBX is the registered trademark of DBX incorporated.

**Specifications are subject to change without notice.

Characteristics Diagrams

CASSETTE DECK PLAYBACK

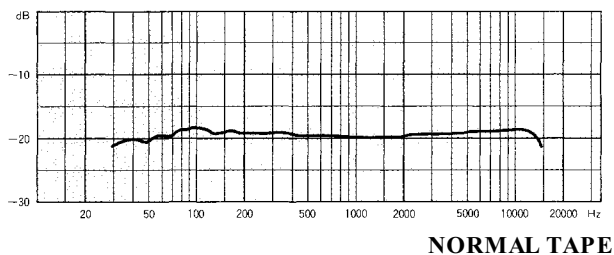

RECORDING PLAYBACK

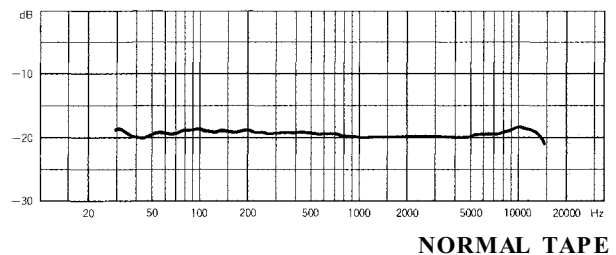

Characteristics Diagrams

HIGH Z IN. TRIM/MIN & INPUT EQ

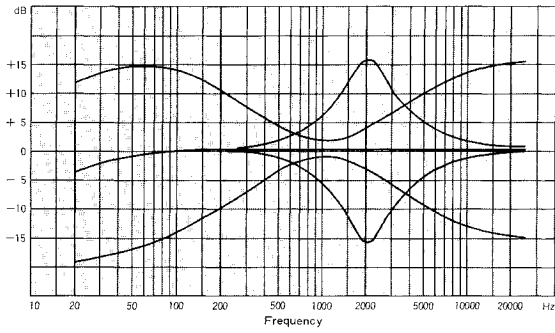

GEQ

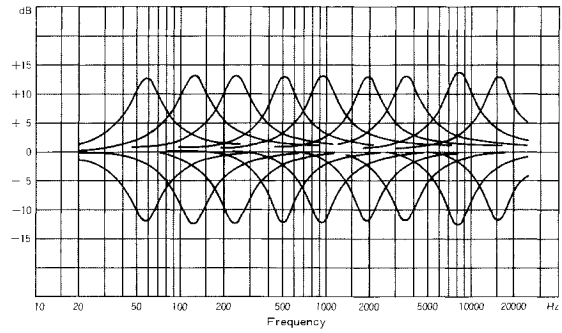

POWER AMP POWER BAND WIDTH

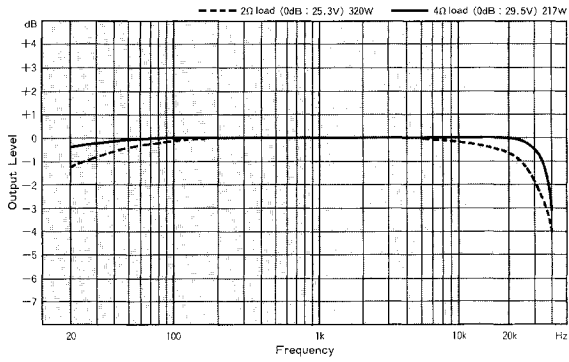

POWER AMP TOTAL HARMONIC DISTORTION

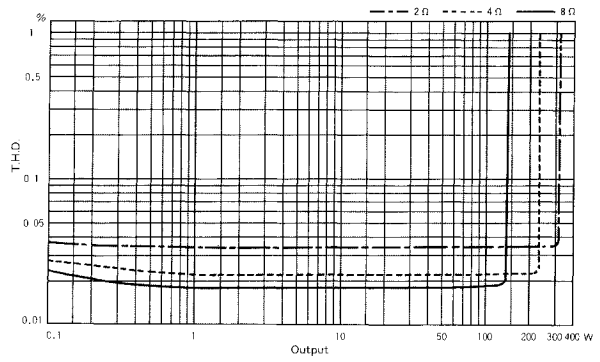

POWER AMP COMPRESSOR

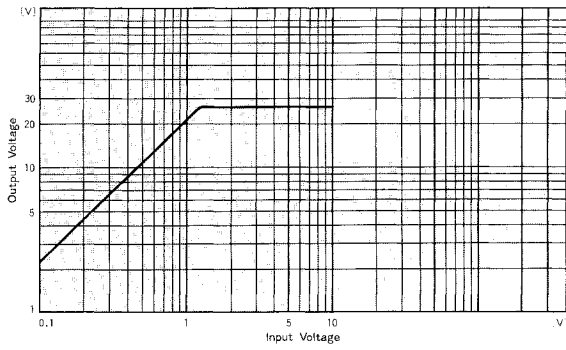

REVERBERATION FREQUENCY RESPONSE

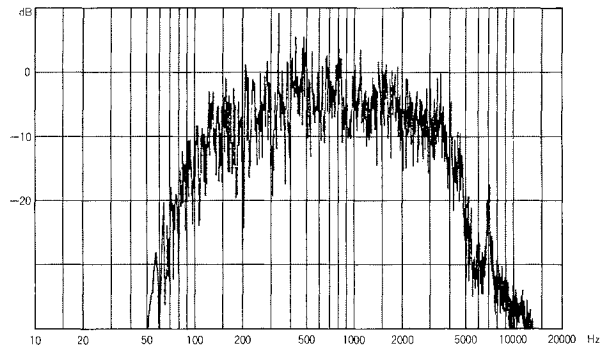

Appearance

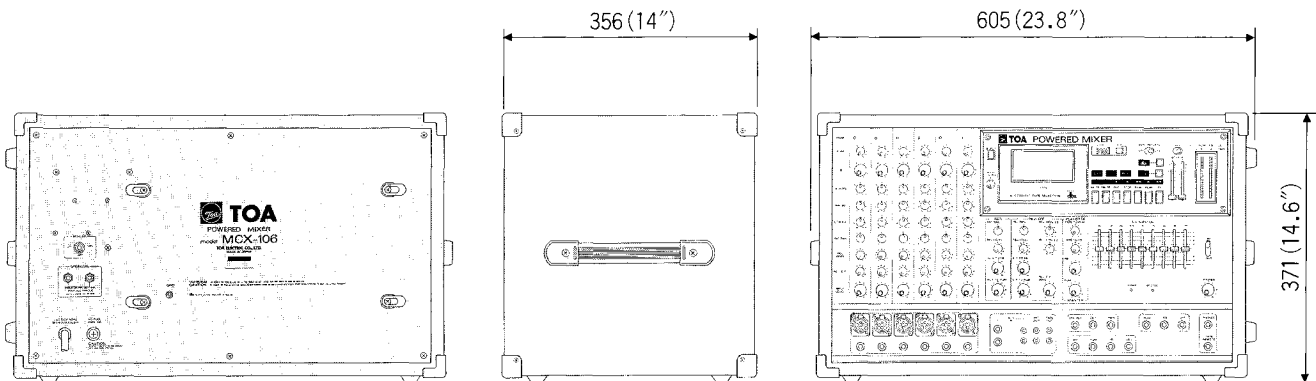



TOA ELECTRIC CO., LTD.

KOBE, JAPAN