



CP-63

Functions and Operating Instructions



TOA ELECTRIC CO, LTD.
KOBE, JAPAN

Contents

1. Introduction to the "Functions and Operating Instructions" for stations for EXES-6000	2	11. Description of each function	
2. Tie-line connections of exchanges	3	1) Automatic Line Release	25
3. Part names and functions of the station keyboard	5	2) Camp-On-Busy	25
4. Functions: EXES-6000 CP-63	6	3) Privacy	25
5. Function description	8	4) Camp-On-Privacy	26
6. Restrictions resulting from tie-line connection	10	5) Press-To-Talk	26
7. EXES-6000 CP-63 Summary of dial operations	11	6) Talk Back	27
8. Stations	13	7) Single Digit Dialing	28
9. Speech functions	14	8) Master/Sub Relationship	29
10. Station operation		9) Automatic Access To Paging	29
1) Handset master station (TL-600M)	15	10) Personal Number Call	30
2) Handset substation (TL-600S)	15	11) Continuous Calling Tone	31
3) Hands-free master station (HF-620M/630M/631M/650M)	16	12) Remote Response	32
4) Hands-free substation (HF-620S/630S/631S/640S)	18	13) Call Transfer, Paging during Normal Calls.	33
5) Hands-free/handset master station (HF-600M/610M/660M)	20	14) Group Hunting	34
6) Hands-free/handset substation (HF-600S/610S)	22	15) Secretary Transfer	35
7) Hands-free/handset master station with auto-dialer (HF-660M)	24	16) Executive Priority (Highest Priority)	38
		17) Conference	39
		18) Paging	40
		19) How to Select the Paging Area and Make the Paging Call	41
		20) All-Call Paging and Individual Zone Paging	42
		21) Selectable First Station Number of Each Exchange	43
		22) Programmable Station Numbering	44
		23) Group Blocking	45
		24) Programmable Restricted Access for Stations	47
		25) Selectable Calling Tone	48
		26) Selectable Paging Pre-Announcement Tone Duration	48
		27) Time-Out of Conversation	48
		28) Time-Out of Paging Call	48
		29) In/Out Annunciation	49
		30) Calling Party Indication [Lamp Type]	50
		31) Pocket Pager	52
		32) General Purpose Control	53
		33) Simplified Paging	55
		34) Clear Entry and Conversation Over	55

Introduction to the "Functions and Operating Instructions" for stations for EXES-6000

This handbook explains the functions and operating procedures of stations for TOA's EXES-6000 Intercom System using central processing unit CP-63 (for tie-line system) and exchanges EX-610/620.

Designed for connection of up to 3 exchanges, the EXES-6000 system permits you to talk with the person in the remote area, and also to increase the number of stations which one (1) exchange cannot cover.

This handbook deals with

1. Explanation of the tie-line system and restrictions of each function (See items 2, 4 through 6 and 11)
2. Basic use of each station (See items 3 and 8 through 10).
3. Functions and dial operations (See items 4 through 7 and 11)

Please note that performances of some functions are restricted in the tie-line system.

You need not read all the instructions given in this handbook but it is necessary to read the instructions on those functions employed in your system. The following guidelines will help you select the pages that you should read.

Selecting different functions made available by placing the Privacy Switch in the "ON" position

The EXES-6000 System is designed to allow either "PV" type operation (The system having Privacy function) or "NP" type (Without Privacy function) to be selected by turning on or off a switch inside the exchange. It is impossible to make one station the "NP" type and another the "PV" type in the same system.

The function provided when the Privacy switch is in the ON position is different between the "PV" and the "NP" type. Therefore, read the page marked **PV Type** if your system is of the "PV" type and the Page **NP Type** if it is of the "NP" type.

"PV" Type and "NP" Type

Type	Definition	Description
PV Type	System having Privacy function	<ol style="list-style-type: none"> 1. Privacy tone With the Privacy switch in the ON position, a brief Privacy tone sounds and any incoming call is refused. 2. The Handset Master/Substation may not be used in this system. If used, it is not called by a continuous calling tone but by a brief Privacy tone.
NP Type	System having no Privacy function	<ol style="list-style-type: none"> 1. Continuous calling tone A station with the Privacy switch may be called by the continuous calling tone when its Privacy switch is placed in the ON position. One touch dialing any key (1 through 9, 0, *, #) other than the PTT key or picking up the handset stops the calling tone and the stations is made ready to initiate the response to the call. 2. The Handset Master station without Privacy switch may be called by the continuous calling tone. Picking up the handset stops the calling tone and allows the conversation.

Note.

By programming, the continuous calling tone function may be made available to specific stations with the Privacy switch in the OFF position.

In this event, touch dialing any key (1 through 9, 0, *, #) other than the **PTT** key stops the calling tone and permits conversation.

This feature may be employed for the industrial type of station (Model HF-650M) or in the "PV" type system that needs to be continuously called.

Tie-line Connections of Exchanges

1. Purpose of tie-line connection

When the EXES-6000 system uses the Central Processing Unit Model CP-63, not only the use of a single exchange (up to 120 stations) but also the tie-line connections of 2 exchanges (up to 240 stations and without paging functions) or 3 exchanges (up to 360 stations and without paging functions) are possible.

This tie-line function may be used when

- 1) You wish to connect 2 or 3 exchanges in the remote areas (maximum distance connected between exchanges using the cable of 0.65mm diameter is approximately 2 km.)
- 2) One exchange is not sufficient enough to cover the desired number of stations and a separate exchange is required for increase in the number of stations.

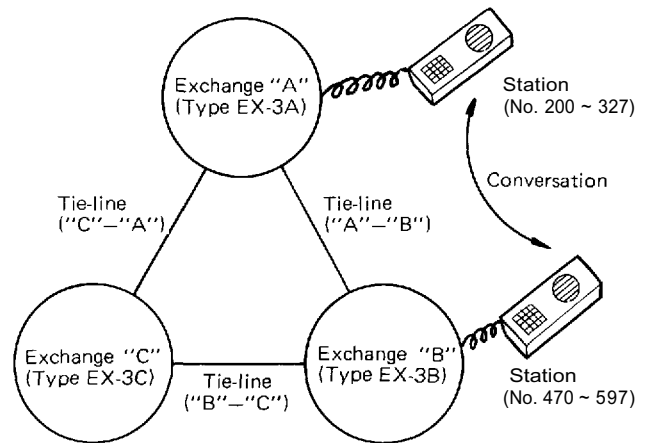
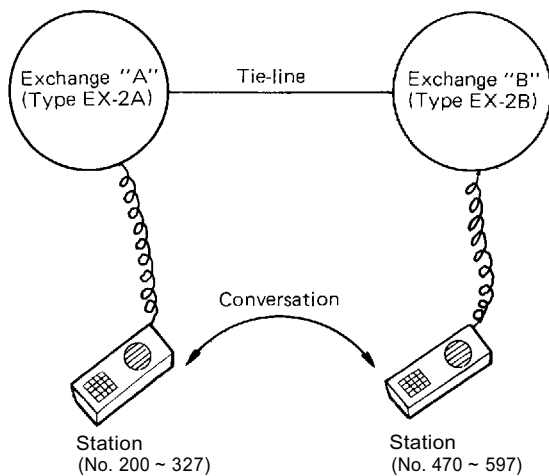

2. Number of stations, paging zones and links

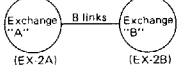
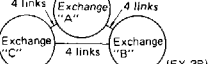
Composition of exchange(s)	Maximum number of links within own exchange		Maximum number of links between tie-lined exchanges	Number of exchange	Maximum number of paging zones	Maximum number of stations			
	EX-610	EX-620				Without Paging		With Paging (All call +7 zones)	
						EX-610	EX-620	EX-610	EX-620
(1) Without tie-lines 	12	16	X	1	All call + 7 zones	56	120	48	112
(2) 2 exchanges 	12	16	8	1	All call + 7 zones	56	120	48	112
	*1	*1		2	All call +14 zones *2	112	240	96	224
(3) 3 exchanges 	12	16	4 between each tielined link	1	All call +7 zones	56	120	48	112
	*1	*1		3	All call +21 zones *2	168	360	144	336

*1 The links within own exchange as well as the tie-line links are used in each tie-line communication.

*2 All call paging is provided to all the paging zones of all the exchanges connected by tie-line.

3. Numbering schedule for stations and paging zones

(1) With Personal number (Standard)

Type of exchange	Model	Numbering for stations		Numbering for paging zones	
		Without Paging	With Paging (7 zones per exchange)	Paging zone per exchange	
				All call	Zone
Single Exchange (EX-1) Exchange "A" (EX-2A/3A)	EX-610	200~247, 256~263	200~247	00	01~07
	EX-620	200~311, 320~327	200~311		
Exchange "B" (EX-2B/3B)	EX-610	470~517, 526~533	470~517		08~14
	EX-620	470~581, 590~597	470~581		(16~22)*
Exchange "C" (EX-3C)	EX-610	740~787, 796~803	740~787		15~21
	EX-620	740~851, 860~867	740~851		(31~37)*

(2) Without Personal number

Type of exchange	Model	Numbering for stations		Numbering for paging zones	
		Without Paging	With Paging (7 zones per exchange)	Paging zone per exchange	
				All call	Zone
Single Exchange (EX-1) Exchange "A" (EX-2A/3A)	EX-610	100~147, 156~163	100~147	00	01~07
	EX-620	100~211, 220~227	100~211		
Exchange "B" (EX-2B/3B)	EX-610	400~447, 456~463	400~447		08~14
	EX-620	400~511, 520~527	400~511		(16~22) *
Exchange "C" (EX-3C)	EX-610	700~747, 756~763	700~747		15~21
	EX-620	700~811, 820~827	700~811		(31~37) *

Note Zone No.16 through 22 and No.31 through 37 are employed for
 *: Paging Numbering Schedule of 45 zones with 3 exchanges established in the system using the exchanges EX-610 and/or EX-620 and EX-630 (256 stations) connected by tie-line.

Part names and functions of the station keyboard

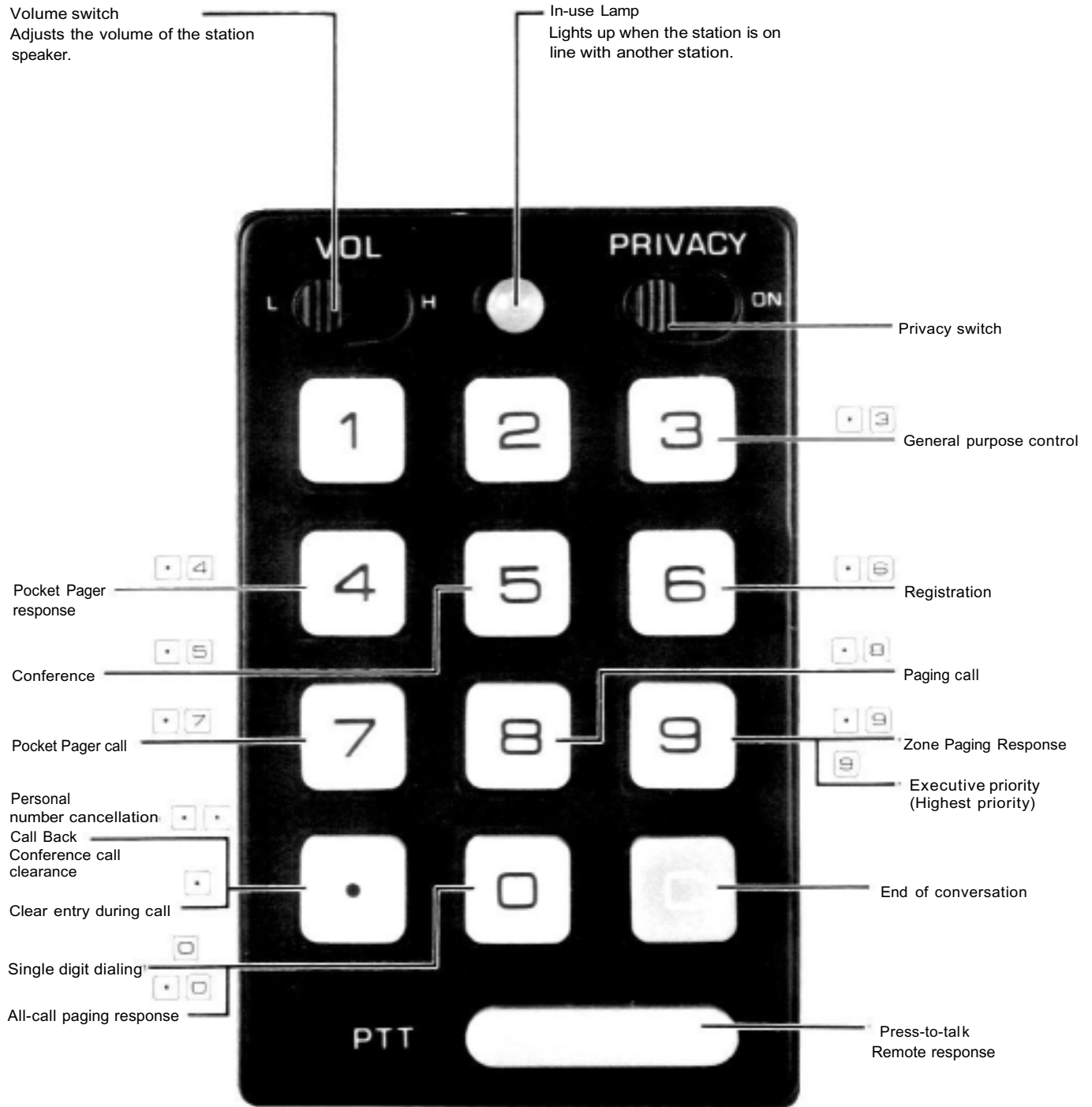

Functions: EXES-6000 CP-63

No.	Classification	Function	Standard Function	Selectable Function		Optional Function	Own Exchange	Outside Exchange	
				By DIP Switch	By No. 200 Programming				
1		Automatic Line Release	0				0	0	
2		Camp-On-Busy	0				0	0	
3	Single Digit	Single Digit Dialing	0				0	0	
4		Automatic Access to Paging			0		0	0	
5		Master/Sub Relationship			0		0	X	
6	Continuous Calling Tone	Privacy • Camp-On-Privacy/Continuous Calling Tone at Privacy Mode *1		0			0	0	
7		Continuous Calling Tone • One-touch Response *2		0	0		0	0	
8	PTT	Press-To-Talk	0				0	0	
9		Talk-Back				0	0	0	
10		Personal Number Call		0			0	0	
11	Transfer	Remote Response	0				0	X	
12		Call Transfer • Paging during Normal calls		0		(0)*3	0	X	
13		Group Hunting		0	0		0	X	
14		Secretary Transfer		0	0		0	X	
15	Priority	Executive Priority (Highest Priority)		0	0		0	0	
16	Conference	Conference		0		0	0	0	
17	Paging and Response	Station Paging (All-Call + 7 zones/Exchange) *4		0	(0)*5	0	0	0	
18		PA Paging (All-Call + 7 zones/Exchange) *4		0	(0)*5	0	0	0	
19	Selection of Dial Operation	Selectable Numbering Schedules of Tie-line System No. 100-400-700/No. 200-470-740		0			0	0	
20		Selectable First Station Number of Each Exchange No. 100/200/300/400/500/600/700/800/900			0		0	0	
21		Selectable Dial Operation for Paging Response		0			0	0*6	
22		Programmable Station Numbering		0	0		0	0*7	
23	Restricted Access	Group Blocking (Restricted Dialing)		0	0		0	0	
24		Restricted Access to All-Call Paging			0		0	0	
		Restricted Access to Conference			0		0	0	
		Restricted Access to General Purpose Control	One-shot make output		0			0	X
			Make/break output		0			0	X
			8 selectable make output/Decimal output			0		0	X
			4 decimal digits output			0		0	X
25	Selection	Calling Tone • Paging Pre-Announcement Tone Duration *8			0		0	0	
26		Time out of Conversation and Paging Call			0		0	0	
27	Interface	IN/OUT Annunciation		0			0	0	
28		Calling Party Indication(Lamptype)(with/without memory)		0*9	0	0	0	X	
29		Pager (Make output type)		0		0	0	0*10	
30		General Purpose Control	One-shot make output					0	0
	Make/break output						0	0	
	8 selectable make output/Decimal output						0	0	
	4 decimal digits output						0	0	

Functions: EXES-6000 CP-63

Notes.

1. XX/YY indicates to select either XX (Function) or YY (Function).
2. Not all circles (O) in The Switch Selection table correspond to the DIP switches of the CP unit.
- *1: "PV" (system with Privacy function) Type: with the Privacy switch in the ON position, a brief Privacy Tone sounds.
"NP" (system without Privacy function) Type: A station may be called by the continuous calling tone when the Privacy switch is placed in the ON position.
- *2: When a hands-free station without handset is called by the continuous calling tone, conversation may start by touching any key
- *3: Additional equipment is required for paging.
- *4: Each zone of paging provides Station paging and/or PA paging. (Within 7 zones per exchange)
- *5: It is necessary to respond only by touching (without zone No.)
- *6: It is possible to make a paging and its response across the other exchange. However, a response to the zone paging is possible only from a station connected to the exchange having the paged zone.
- *7: Station numbers of each exchange can be changed freely within the range of "Selectable numbering schedule of each exchange".
- *8: Calling tone: 0.3 sec (Trill note tone)/0.2 sec (Single note tone)/none.
Paging pre-announcement tone: 2 sec/1 sec/none.
- *9: Selects whether or not the indication of the calling party station continuously lights up, after the calling party has cancelled the call to a line which is busy or in the privacy mode.
- *10: A call can only be made from the stations No. 200 ~ 327 connected to the "A" type exchange. It is possible to respond from any station.

Function description

Besides fixed standard functions, there are selectable standard functions and optional functions. Selectable standard functions can be selected by changing over The CP Unit switches and by establishing station No. 200 programming. Optional functions can be made available by using external equipment or additional units.

1. Standard Functions

1-1. Available across the other exchange

1) Automatic Line Release

The calling Station is released from the speech path if dialing is not completed within 5 seconds. The calling station is also released from the speech path if no response is given within 10 seconds, when calling a station in the privacy mode.

2) Camp-on-Busy

When the called party is busy, the caller can camp-on the line. After the conversation is finished, he is automatically put through.

3) Press-to-Talk

One-way conversation is possible by pressing the Press-to-Talk bar when the ambient noise is high at one party's station.

4) Single Digit Dialing

Single digit calling of numbers up to 4 digits in length can be made by one-touch operation.

1-2. Available only within the same exchange

5) Remote response

The station called by continuous calling tone can be remotely answered by other stations.

2. Selectable Functions

2-1. Available across the other exchange

6) Privacy

When calls are unwanted, turn Privacy switch on and a brief privacy tone sounds when the station is called.

7) Camp-on-Privacy

When called in the privacy mode from another station, calls can be connected immediately after releasing the Privacy switch.

8) Handset Response in Continuously Called Stations

Full duplex handset conversation is available by lifting the handset when the continuous calling tone is heard.

9) One-touch Response in Continuously Called Stations

Hands-free conversation is available by just touching any key except **(PTT)** when the continuous calling tone is heard.

10) Personal Number Call

Calls can be connected by using Personal Numbers, other than normal station numbers when Personal Numbers are registered into any designated station.

11) Executive Priority (Highest Priority)

The preprogrammed caller can interrupt forcibly the called party in busy mode. In this event, original conversation is cancelled.

12) Selection of Dial Operation

(1) Numbering Schedules of Tie-line System

The exchanges A, B and C permit the following standard station Numbering Schedules: (Hardwired station number)

Type of Exchange	A	B	C
With Personal Number (Standard)	200~	470~	740~
Without Personal Number	100~	400~	700~

(2) Selectable First Station Number of Each Exchange

The first station number of each exchange can be selected from any of the following numbers (Hardwired station number): 100/200/300/400/500/600/700/800/900.

The system with Personal Numbers can't use No. 100.

(3) Paging Response

Paging response may be made either by pressing the "Zone No.", or [Simply pressing].

13) Programmable Station Numbering

The system has programmable station numbers up to No. 999 other than the normal hardwired station numbers.

14) Group Blocking (Restricted Dialing)

Stations can be blocked into groups which cannot call or page each other unless further programming is done.

15) Restricted Access

Stations with access to All-call Paging, Conference and General Purpose Control can be limited.

16) Selectable Calling Tone

(Calling Tone/Paging Pre-Announcement Tone)

The time duration of the Calling Tone can be set for "long" (Trill note tone) or "short" (Single note tone) or none. Similarly, Paging Pre-Announcement Tone may be set for "long" (2 sec.) or "short" (1 sec.) or none.

17) Time-out of Conversation and Paging Call

A Calling Time Limitation can be set, in case paging and normal calls are to be kept short or where cancelling calls might be forgotten.

18) Automatic Access to Paging

Specific Substations may initiate a Paging Call or Paging Response or Personal Number Call, etc. by simply picking up a handset.

2-2. Available only within the same exchange

19) Master/Sub Relationship

Substations can call Master stations by one-touch operation. In the event of Handset Substation, a call can be made from Substation to its designated master station by simply picking up a handset.

20) Call Transfer

The called party can transfer the call to other selected station. Call Hold and Call Back are also possible.

21) Paging during Normal Calls

Calls can be transferred to a third party after paging while speaking.

22) Group Hunting

When the first called party in a group is busy, the call is automatically transferred to the next stations.

23) Secretary Transfer

Calls to an "Executive" may be automatically transferred to a "Secretary".

3. Optional Functions

3-1. Available across the other exchange

24) Station Paging and Response (PI-62 Unit is required)

Paging is available through the built-in station speakers. Paging calls can be responded to by the nearest master station.

25) PA Paging and Response

(PI-62 Unit and PA System are required)
Paging through PA System and response.

26) Conference (CL-62 Unit is required)

Conference calls can be made including up to 4 persons.

27) Talk-Back

(Talk-Back Unit and PA system are required)
Press-to-talk conversation is done by employing external PA speakers.

28) Simplified Paging

Simplified PA paging is possible if an external speaker is connected instead of a station.

29) In/Out Annunciation

(Interface for the Indicator Board needs to be made by using Data Transmitter DT-E11 and Receiver DR-B61)

In or Out status is annunciated by registration/cancellation of Personal Numbers.

3-2. Available only within the same exchange

30) General Purpose Control

(Make the Indicator Board and General Purpose Control Interface by using Data Transmitter DT-E11 and Receiver DR-B61)

Various types of Relay Output modes for control are available. Use as Remote Control for such applications as In/Out Annunciation, Destination Annunciation Indication, VTR and ITV.

31) Calling Party Indication [Lamp Type]

(Interface for the Indicator Board is made by using Data Transmitter DT-E11 and Receiver DR-B61)

The lamp of the calling party comes on when a call is made. The calling party is kept in display while the called party is in the privacy or busy mode. It is also possible to continue the lamp indication for the later reference for the calling party.

32) Pager Calling and Response

(Make Interface for this purpose by using Data Transmitter DT-E11 and Receiver DR-B61)

Pagers with relay input interface can be connected.

A call can only be made from the stations No. 200~327 connected to the "A" type exchange. It is possible to respond from any station.

Restrictions Resulting from Tie-line Connection

1. Number of stations

The total number of stations that can be connected to each exchange using the CP-63 is smaller than that of the system employing the CP-62 by 8.

2. Paging

- 1) Paging is possible up to a maximum number of 7 zones per exchange.
- 2) It is possible to make paging to all zones (14 zones for 2 exchanges and 21 zones for 3 exchanges) by means of All-call paging.
- 3) All-call paging and zone paging are possible from any master station.
- 4) It is possible to respond to All-call paging from any master station.
- 5) A response to the zone paging is possible only from a station connected to the exchange that includes the paged zone (Exchange "A": Zone No. 1 ~ 7, "B": No. 8 ~ 14, "C": No. 15 ~ 21). It is not impossible to respond from the station connected to the other exchange.
When the Automatic Response () is employed, the response to the zone paging is made only from the station (consecutive station numbers) linked to the paged zone.
- 6) It is impossible to allocate the same paging zone to 2 exchanges.

3. Programmable Station Numbering

It is possible to change a station number series of each exchange freely within the range of "Selectable numbering schedule of each exchange".

4. Group Blocking

- 1) The system can be grouped or divided into a maximum of 6 groups of stations by each exchange.
- 2) The group can call and/or be called by any other group(s) within the same exchange area by programming.
- 3) Only one pair of groups can call each other across the tie-lined exchange.
- 4) The group of stations which can make All-call paging and zone paging (No. 1~21) can be set up.
- 5) To make a paging response possible, the calling and the called groups must be set up. The paging response can be made from the called group to the calling group (the opposite direction of call restrictions).











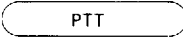





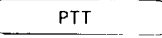

















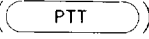



























5. When connected by tie-line, the following functions are available within the same exchange but unavailable across the other exchange:

- 1) Remote Response
Select the Remote response group within the stations connected to the same exchange.
- 2) Master-Sub Relationship
Set up Master/Substation associations within the same exchange area.
- 3) Transfer
An original call can be transferred only to the third party who shares the same exchange with the party who transfers the call.
- 4) Paging during Normal Calls
Paging during a normal call is only possible within the paging zones allocated to the exchange to which a station making the paging is connected.
- 5) Group Hunting
Select the station to which the call is to be transferred within the same exchange group.
- 6) Secretary Transfer
Set up a Secretary/Executive association within a group of stations connected to the same exchange.
- 7) General Purpose Control (One-shot Make Output, Make/Break Output, 8 Selectable Make Output, Decimal Output, 4 Decimal Digits Output)
Only the Data Transmitting and Receiving Units connected to the same exchange can be operated.
- 8) Calling Party Indication (Lamp type)
The lamp at the station which receives the call turns on only when the call is made from the station within the same exchange area (Max. of 120 stations). The lamp does not light if the call is made from the stations connected to the other exchange(s).
- 9) Pager Call
A call can only be made from the stations No. 200 ~ 327 connected to the "A" type exchange. It is possible to respond from any station.

EXES-6000, CP-63 Summary of Dial Operations

Tie-line system of 2 or 3 exchanges

- Station numbering:
1. No. 200 ~ 327, No. 470 ~ 597, No. 740 ~ 867 (standard)
 2. No. 100 ~ 227, No. 400 ~ 527, No. 700 ~ 827 (without personal number)
 3. No. 200 (100) ~ 999 (programmable station numbering)

Classification	Function	Dial operation	Number	Description
Call	Press-to-talk	 Symplex   Duplex		Conversation is simplex when PTT bar is used.
	Remote response			When a station is called by continuous calling tone, near station in the groups can respond the call instead of the called station.
	Remote response registration	      Confirmation tone	X X X : Station No.	Group registration of stations can be made from each station.
	Continuous calling tone response	 ~    or 		Called party touches one of these keys then conversation may begin.
	Privacy	PRIVACY  ON Privacy off  ON		When a party does not wish to accept incoming calls, set the Privacy Switch in the ON position.
	Secretary transfer	PRIVACY  ON Secretary transfer off  ON		This function allows for automatic transfer of calls to a secretary when desired.
	Single digit registration	    • •  () Registration dials (maximum 4 digits)		This function allows for single digit registration of up to 4 digits among the numbers 0 through 9 and the  key.
	Single digit dialing			Registered dial code may be automatically dialed.
	Personal number registration In/Out annunciation-lamp ON	      Confirmation tone	1 X X X : 1000 ~ 1499	Personal number may be registered at any master station which the person to whom the number is assigned expects to be.
	Personal number cancellation In/Out annunciation-lamp OFF	      Confirmation tone		When anyone having a personal number leaves the office he merely cancels the programming of his personal number.
	Personal number call	   		A personal number dialing enables the station call for a person having the personal number.
	Conference	     Calling    Calling	X X X : Station No., Personal No., Single digit number	A conference call may be made with up to 4 persons. Participants must be called individually.
	Conference clear	 		If a person called into a conference is absent, the conference may be returned to the original condition.
	Executive priority (Highest priority)	   Busy tone 	X X X : Station No., Personal No., Single digit number	When the called party is busy, this function allows interruption of the existing conversation and immediate direct contact with the called party.
Call transfer	   Call conversation  Transfer   Conversation with original station		The called party can transfer the call to a selected other station (by station number, personal number or single digit number).	

Classification	Function	Dial operation	Number	Description
Paging	<Tie-line system of 2 exchanges> All-call plus 14-zone paging	• 8 X X	X X : 00 (All-call), 01~14 (Zone)	Any station can be used to initiate PA or station paging. A person paged can respond from the nearest master station.
	<Tie-line system of 3 exchanges> All-call plus 21-zone paging	• 8 X X	X X : 00 (All-call), 01 ~ 21 (Zone)	
	All-call response	• 0 or • 9 0 0		Response to all-call
	Zone paging response	• 9 or • 9 X X	X X : 01 ~ 21	Response to zone paging
	Paging during normal call	Conversation • 8 X X Paging C Transfer ↓ ↗ Conversation after response ⇒ • • Conversation with original station	X X : 01 ~ 07 (Exchange A) 08 ~ 14 (Exchange B) 15 ~ 21 (Exchange C)	This function allows a called party to transfer the call to a third party who responds to paging.
Display and Control Data Transmitting and Receiving Unit	One-shot make output	• 3 X X	X X : 00 ~ 49	One-shot make output of relay may control other equipments such as ITV camera, VTR control, dictating systems, etc.
	Make/break output	• 3 5 X X (Make) • 3 6 X X (Break)	X X : 00 ~ 99	Make/break output of relay may control other equipments.
	8-selectable make output	• 3 7 X Y Unit No. Condition No.	X : 1 ~ 9 Y : 1 ~ 8,0 (Clear)	8 selectable output is available (indicating room status and destination).
	Decimal output	• 3 8 X Y Unit No. Condition No.	X : 1 ~ 9 Y : 0 ~ 9	A decimal output is available (indicating room status and destination).
	4 decimal digits output	• 3 9 X Y Y Y Y Unit No. 4-digits	X : 1 ~ 9 Y Y Y Y : 0000 - 9999	4 decimal digits output is indicated.
	Make output for Pager control	• 7 X X	X X : 00 ~ 63	Control the pocket paper by make output of relays.
	Pocket Pager response	• 4 X X		
	Calling party selection	• 9 X X X	X X X : Station No.	When the indication panel shows several incoming calls at the same time, the called party may select any of them for response.
Clearing calling party indication	C C		This is used to cancel the calling party indication without conversation.	

Stations

- | | | | |
|----------------------|--|-----------------------|---|
| 1. TL-600M | Desk/Wall-Mounted Handset Master Station | 8. HF-620M | Desk/Wall-Mounted Hands-free Master Station |
| 2. TL-600S | Desk/Wall-Mounted Handset Sub-Station | 9. HF-620S | Desk/Wall-Mounted Hands-free Sub-station |
| 3. HF-660M | Desk/Wall-Mounted Hands-free / Handset Master Station with Auto-Dialer (8 keys — 16 registrations) | 10. HF-630M | Flush-Mounted Hands-free Master Station |
| 4. HF-600M | Desk Hands-free / Handset Master Station | 11. HF-630S | Flush-Mounted Hands-free Sub-station |
| 5. HF-600S | Desk Hands-free / Handset Substation | 12. HF-631M | Flush-Mounted Hands-free Master Station (Stainless steel panel) |
| 6. HF-610M | Flush-Mounted Hands-free / Handset Master Station | 13. HF-631S | Flush-Mounted Hands-free Sub-station (Stainless steel panel) |
| 7. HF-610S | Flush-Mounted Hands-free / Handset Substation | 14. HF-640S | Door Station (Hands-free) |
| | | 15. HF-650M | Surface-Mounted Industrial Master Station (Hands-free) |

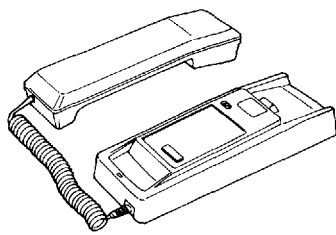

TL-600S

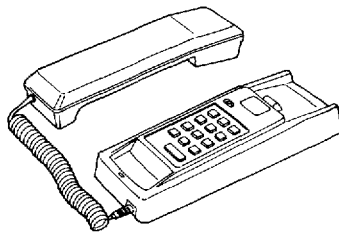

TL-600M

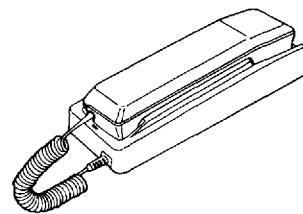

TL-600M/S

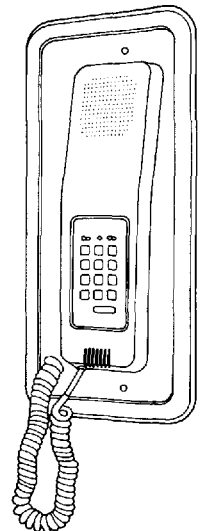

HF-610M

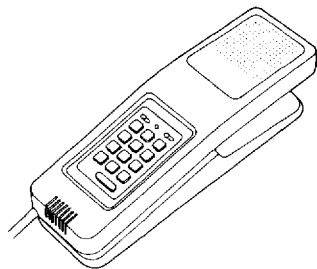

HF-600M

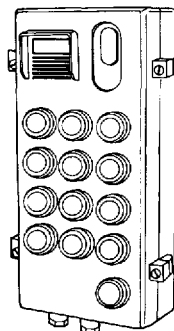

HF-650M

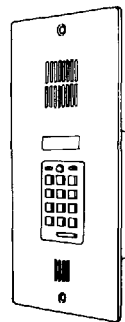

HF-630M

HF-631 M

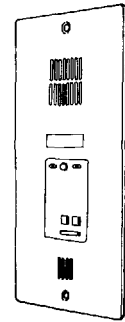

HF-630S

HF-631S

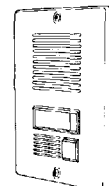

HF-640S

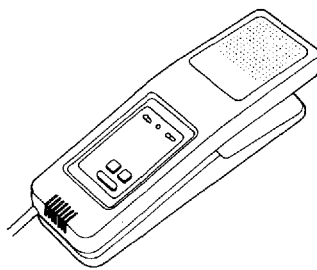

HF-600S

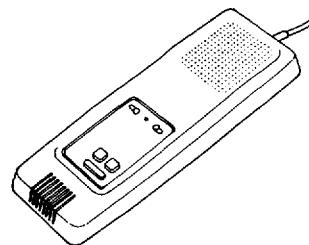

HF-620S

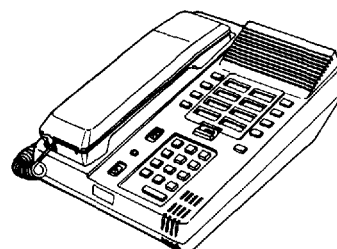

HF-660M

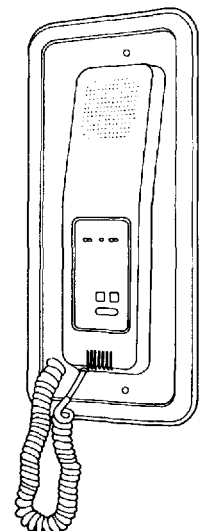

HF-610S

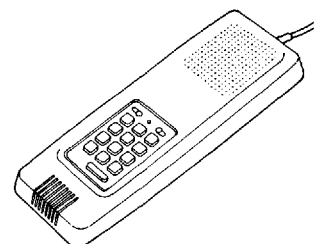

HF-620M

Speech functions

Either "PV" Type (the system with Privacy function) or "NP" Type (Without Privacy function) mode should be selected in the total intercom system.

When Privacy Switch (SW) of station is turned ON, privacy tone is available in "PV" Type system, while continuous calling tone is available in "NP" Type system.

	Functions	System types		Descriptions	Stations		Privacy SW
		PV	NP		Without Privacy SW	With Privacy SW	
Calling	Dialing	○	○	Calls are made by touching dial. Even if the Privacy SW is on, calling is possible.	HF-650M	HF-660M HF-600M, 610M HF-620M, 630M HF-631M	ON/OFF
	One-Touch Dialing	○	○	Substations can make a call to designated Master Stations by one-touch dialing. Calling is possible even if the Privacy SW is on.	HF-640S	HF-600S HF-610S, 620S HF-630S, 631S	ON/OFF
	Dialing after Handset is picked up	X	○	Calls can be made by touching dial button after picking up handset, and confirming dial tone is heard.	TL-600M	HF-660M HF-600M HF-610M	ON
	Calling by picking up Handset	X	○	Substations can make a call to designated Master Stations just by picking up the handset.	TL-600S	HF-600S HF-610S	ON
Voice	Voice Calling	○	○	When called by continuous calling tone or privacy tone, voice can be sent by pressing (PTT) bar.	All stations except HF-640S		ON/OFF
Receiving	Hands-free Calling and Conversation	○	○	With touch-dial, after a brief calling tone Hands-free conversation is available.	HF-640S HF-650M	HF-660M HF-600M/S HF-610M/S 620M/S HF-630M/S 631M/S	OFF
	Continuous Calling Tone Response by One-Touch Dialing (No. 200 programming) *1	○	○	With touch-dial, a continuous calling tone is sent. Hands-free Conversation is available when called party depresses, the <input type="checkbox"/> ~ <input type="checkbox"/> , <input type="checkbox"/> or <input type="checkbox"/> key	HF-640S HF-650M	HF-660M HF-600M/S HF-610M/S 620M/S 630M/S 631M/S	OFF
	Privacy	○	X	When calls are unwanted, turn ON Privacy SW. Then, a brief privacy tone sounds when called. By turning off Privacy SW or touching any key (<input type="checkbox"/> ~ <input type="checkbox"/> , <input type="checkbox"/> , <input type="checkbox"/> key) or picking up a handset, conversation becomes available.	—	HF-660M HF-600M/S HF-610M/S HF-620M/S HF-630M/S HF-631M/S	ON
	Continuous Calling Tone-Picking up Response (in Privacy Mode)	X	○	When called by Continuous Calling Tone, conversation is possible by picking up handset.	TL-600M/S	HF-660M HF-600M/S HF-610M/S	ON
	Continuous Calling Tone-One-Touch Response (in Privacy Mode)	X	○	Calls can be made just by touching the <input type="checkbox"/> ~ <input type="checkbox"/> , <input type="checkbox"/> or <input type="checkbox"/> key. Without picking up handset when called by Continuous Calling Tone.	—	HF-660M HF-600M/S HF-610M/S	ON
Speech Methods	Voice Switch Conversation	○	○	Voice switch conversation is available automatically, when two parties speak in hands-free mode.	HF-640S HF-650M	HF-660M HF-600M/S 610M/S HF-620M/S HF-630M/S 631M/S	ON/OFF
	Simplex Conversation by Press-to-Talk key	○	○	One-way conversation is available by a party who presses (PTT)	HF-640S HF-650M	HF-660M HF-600M/S HF-610M/S HF-620M/S HF-630M/S 631M/S	ON/OFF
	Full Duplex Conversation	○	○	Full duplex conversation is available when one or two parties are speaking using a handset.	TL-600M/S HF-640S HF-650M	HF-660M HF-600M/S 610M/S HF-620M/S 630M/S HF-631M/S	ON/OFF

*1 This function may be employed for the industrial type of station (Model HF-650M) or in the "PV" type system that needs to be continuously called.

Station operation

1. Handset Master Station

Model TL-600M

NP Type

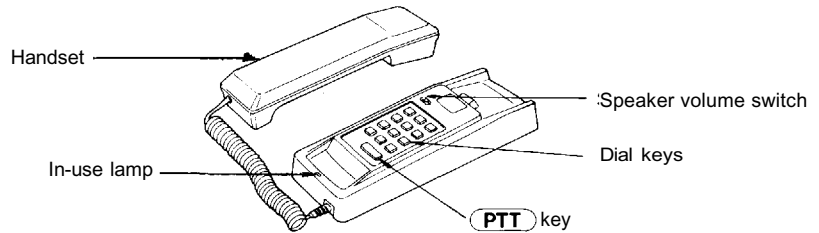
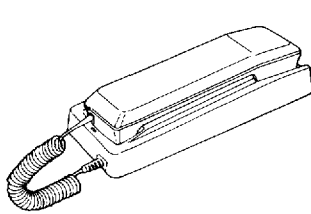

< Making a call >

1. Pick up the handset and touch dial the station number of the party you wish to talk to after hearing dial tone.
2. Start conversation after the calling tone stops.
3. When you hear a busy tone that indicates the party you call is on another line, you can camp on the line by simply waiting without hanging up the handset. As soon as the line becomes free, your call is automatically connected.
4. While the continuous calling tone is sent, you can break in on the calling tone by continuously depressing the **PTT** key to make a voice call through the station speaker of the called party.

5. Hang up the handset or depress the [c] key to terminate the conversation.

< Responding to a call >

6. When you are called by the continuous calling tone or paged through your station speaker, respond to the call by picking up the handset.

Note.

The sound volume of the calling tone may be adjusted by means of a 2-stage volume selector (SP. VOL) switch.

2. Handset Substation

Model TL-600S

NP Type

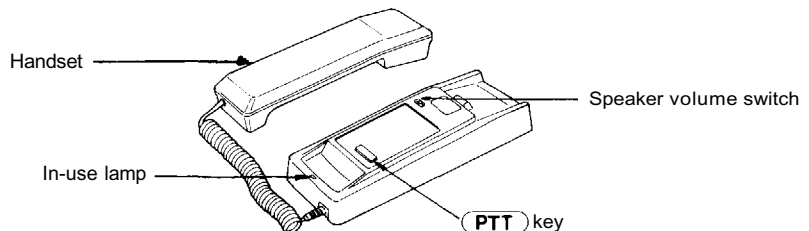
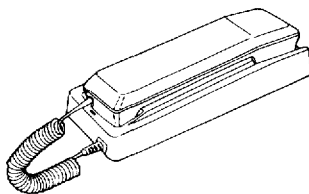

< Making a call >

1. Picking up the handset makes a call to the designated other station.
2. Start conversation after the calling tone stops.
3. When you hear a busy tone that indicates the party you call is on another line, you can camp on the line by simply waiting without hanging up the handset. As soon as the line becomes free, your call is automatically connected.
4. While the continuous calling tone is sent, you can break in on the calling tone by continuously depressing the **PTT** key to make a voice call through the station speaker of the called party.

5. Hang up the handset to terminate the conversation.

< Responding to a call >

6. When you are called by the continuous calling tone or paged through your station speaker, respond to the call by picking up the handset.

Note.

The sound volume of the calling tone may be adjusted by means of a 2-stage volume selector (SP. VOL) switch.

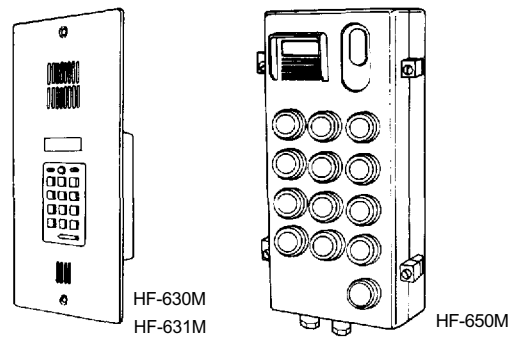
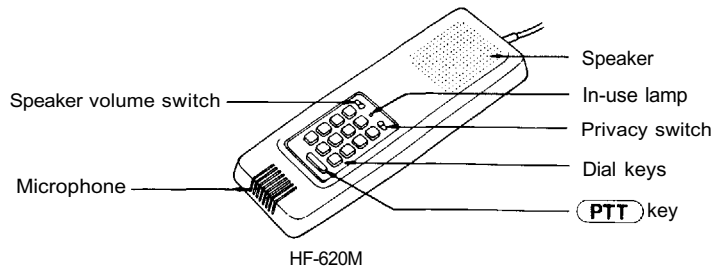
**< Making a call >**

1. Touch dial the station number you wish to call, regardless of whether the Privacy switch of your station is in the ON position or OFF position.
2. Start conversation after the calling tone stops.
3. When the line is busy, a busy tone is heard and you can camp on the line by simply waiting. As soon as the line becomes free, your call is automatically connected.
4. During a call attempt made by means of the continuous calling tone or the Privacy tone, you can break in on the calling tone by continuously depressing the **PTT** key to make a voice call through the station speaker of the called party.
5. When the party you call is in a high noise level area, your continuously depressing the **PTT** key allows one-way conversation to that party. As long as you depress the **PTT** key, your voice has dominance and releasing the **PTT** key will reverse the one-way conversation from that party to you.
6. To terminate the conversation, depress the **[C]** key.

< Responding to a call >

[In the case that the Privacy switch is in the OFF position.]

7. Respond to the call after the calling tone stops.

[In the case that the Privacy switch is in the ON position.]

8. A brief Privacy tone sounds from your station each time there is an incoming call and all incoming calls are refused.

To respond touch dial any key (**[1]~[9], [0], [∗], [C]**) other than the **PTT** key while the line is connected between you and the calling party.

Note.

1. The sound volume of the speaker may be adjusted by means of the 2-stage volume selector (VOL) switch.
2. With no speaker built inside, the HF-650M needs to be connected to a separate speaker. Also, the HF-650M is fitted with no Privacy switch.

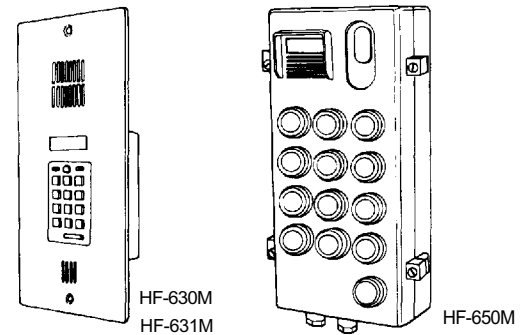
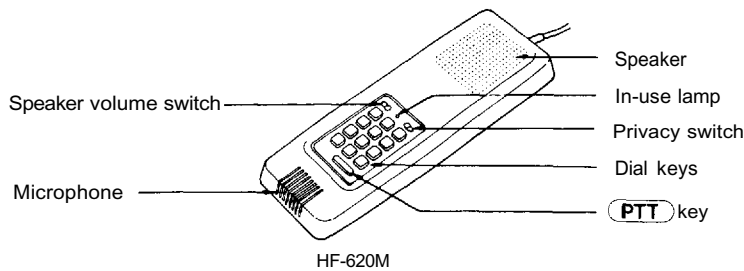
**< Making a call >**

1. Touch dial the station number you wish to call, regardless of whether the Privacy switch of your station is in the ON position or OFF position.
2. Start conversation after the calling tone stops.
3. When the line is busy, a busy tone is heard and you can camp on the line by simply waiting. As soon as the line becomes free, your call is automatically connected.
4. During a call attempt made by means of the continuous calling tone, you can break in on the calling tone by continuously depressing the **PTT** key to make a voice call through the station speaker of the called party.
5. When the party you call is in a high noise level area, your continuously depressing the **PTT** key allows one-way conversation to that party. As long as you depress the **PTT** key, your voice has dominance and releasing the **PTT** key will reverse the one-way conversation from that party to you.
6. To terminate the conversation, depress the **□** key.

< Responding to a call >

[In the case that the Privacy switch is in the OFF position.]

7. Respond to the call after the calling tone stops .

[In the case that the Privacy switch is in the ON position.]

8. The continuous calling tone function is made available to any station if its Privacy switch is placed in the ON position. Depressing any key (**1**~**9**, **□**, **□**) other than the **PTT** key causes the continuous calling tone to stop and puts the station in the conversation mode.

Note.

1. The sound volume of the speaker may be adjusted by means of the 2-stage volume selector (VOL) switch.
2. With no speaker built inside, the HF-650M needs to be connected to a separate speaker. Also, the HF-650M is fitted with no Privacy switch.

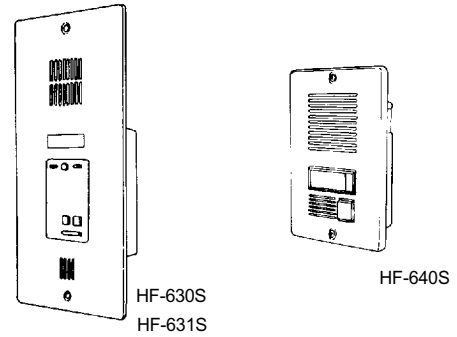
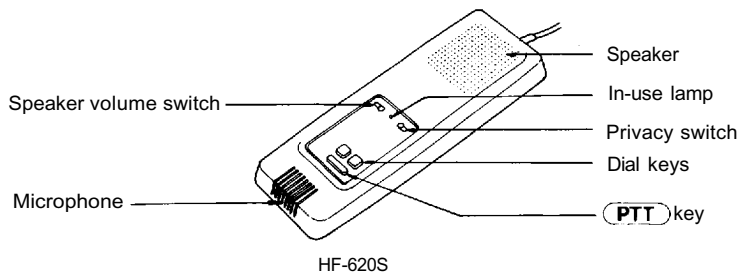
**< Making a call >**

1. Touching the key makes a call to the designated other station whether the Privacy switch on your station is in the ON position or OFF position.
2. Start conversation after the calling tone stops.
3. When the line is busy, a busy tone is heard and you can camp on the line by simply waiting. As soon as the line becomes free, your call is automatically connected.
4. During a call attempt made by means of the continuous calling tone or the Privacy tone, you can break in on the calling tone by continuously depressing the PTT key to make a voice call through the station speaker of the called party.
5. When the party you call is in a high noise level area, your continuously depressing the PTT key allows one-way conversation to that party. As long as you depress the PTT key, your voice has dominance and releasing the PTT key will reverse the one-way conversation from that party to you.
6. To terminate the conversation, depress the key.

< Responding to a call >

[In the case that the Privacy switch is in the OFF position.]

7. Respond to the call after the calling tone stops .

[In the case that the Privacy switch is in the ON position.]

8. A brief Privacy tone sounds from your station each time there is an incoming call, and all incoming calls are refused.

To respond, touch dial the or key while the line is connected between you and the calling party.

Note.

1. The sound volume of the speaker may be adjusted by means of the 2-stage volume selector (VOL) switch.
2. The HF-640S is fitted with no Privacy switch, nor key, nor PTT key.

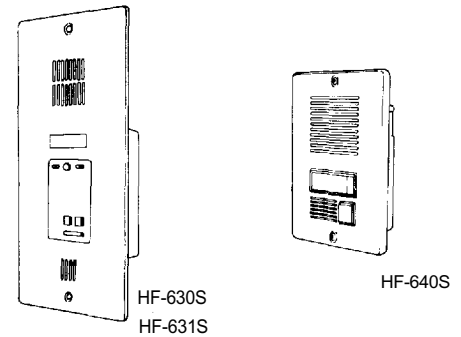
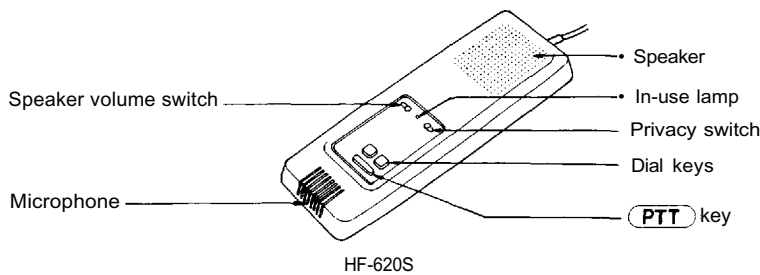
**< Making a call >**

1. Touching the key makes a call to the designated other station whether the Privacy switch on your station is in the ON position or OFF position.
2. Start conversation after the calling tone stops.
3. When the line is busy, a busy tone is heard and you can camp on the line by simply waiting. As soon as the line becomes free, your call is automatically connected.
4. During a call attempt made by means of the continuous calling tone, you can break in on the calling tone by continuously depressing the **PTT** key to make a voice call through the station speaker of the called party.
5. When the party you call is in a high noise level area, your continuously depressing the **PTT** key allows one-way conversation to that party. As long as you depress the **PTT** key, your voice has dominance and releasing the **PTT** key will reverse the one-way conversation from that party to you.
6. To terminate the conversation, depress the key.

< Responding to a call >

[In the case that the Privacy switch is in the OFF position.]

7. Respond to the call after the calling tone stops .

[In the case that the Privacy switch is in the ON position.]

8. The continuous calling tone function is made available to any station when its Privacy switch is in the ON position. Depressing the or key makes the continuous calling tone stop and puts the station in the conversation mode.

Note.

1. The sound volume of the speaker may be adjusted by means of the 2-stage volume selector (VOL) switch.
2. The HF-640S is fitted with no Privacy switch, nor key, nor **PTT** key.

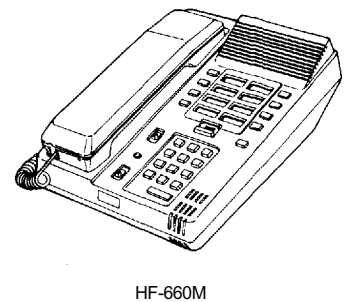
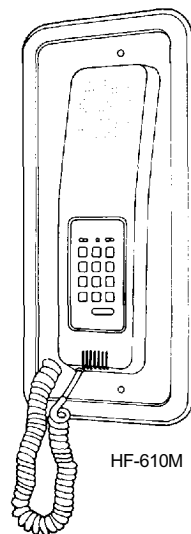
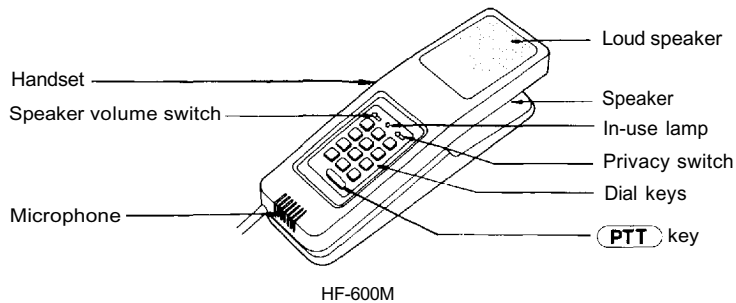

< Making a call >

1. Hands-free conversation may be made by simply touch dialing the station number you wish to call.
2. When you wish to use the handset, pick it up, then touch dial the station number you wish to call, or reverse the order.
3. Start conversation after the calling tone stops.
4. When you hear a busy tone that indicates the party you call is on another line, you can camp on the line by simply waiting. As soon as the line becomes free, your call is automatically connected.
5. In the event that the party you are calling does not respond and the continuous calling tone is still heard from your station, or when the station of that party is in the Privacy mode and the Privacy tone is sounded, you can break in on the calling tone by continuously depressing the **(PTT)** key to make a voice call through the station speaker of the called party.
6. During hands-free conversation, when the person you are talking to is in a high noise level area,
 - (1) Pick up the handset to talk or (2) depress the **(PTT)** key continuously for one-way conversation to that party. As long as the **(PTT)** key is depressed, your voice has dominance, and releasing the **(PTT)** key will reverse the one-way conversation from that party to you.
7. To terminate the conversation, hang up the handset or depress the **(☐)** key.

< Responding to a call >

- [In the case that the Privacy switch is in the OFF position.]
8. Respond to call after the calling tone stops.
- [In the case that the Privacy switch is in the ON position.]
9. A brief Privacy tone will sound from your station each time it receives an incoming call and all incoming calls are refused. To respond, depress any key (**(1) ~ (9), (☐), (☐), (☐)**) other than the **(PTT)** key or pick up the handset while the line is still connected between your station and the calling station. These 2 busy stations are, however, automatically disconnected from the speech path after approximately 10 seconds from call establishment if no response is made by you.

Note.

The sound volume of the loud speaker may be adjusted by means of the 2-stage volume selector (VOL.) switch.

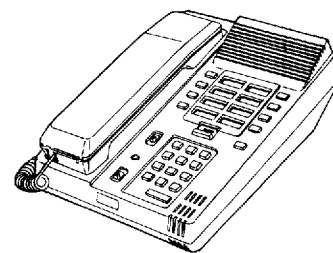
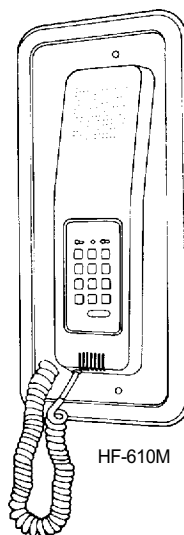
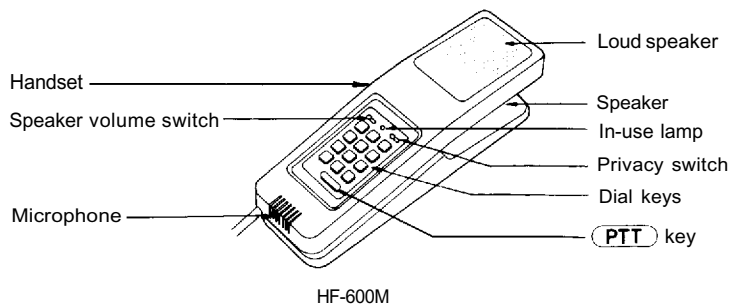

< Making a call >

1. Hands-free conversation may be made by simply touch dialing the station number you wish to call.
2. When you wish to use the handset, pick it up, then touch dial the station number you wish to call, or reverse the order.
3. Start conversation after the calling tone stops.
4. When you hear a busy tone that indicates the party you call is on another line, you can camp on the line by simply waiting. As soon as the line becomes free, your call is automatically connected.
5. In the event that the party you are calling does not respond and the continuous calling tone is still heard from your station, you can break in on the calling tone by continuously depressing the **PTT** key to make a voice call through the station speaker of the called party.
6. During hands-free conversation, when the person you are talking to is in a high noise level area,
 - (1) Pick up the handset to talk or (2) depress the **PTT** key continuously for one-way conversation to that party. As long as the **PTT** key is depressed, your voice has dominance, and releasing the **PTT** key will reverse the one-way conversation from that party to you.
7. To terminate the conversation, hang up the handset or depress the [5] key.

< Responding to a call >





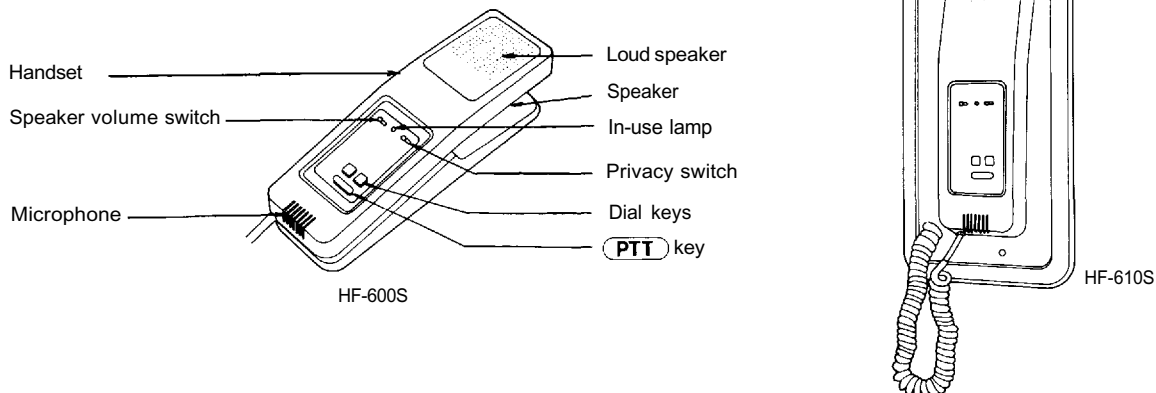

- [In the case that the Privacy switch is in the OFF position.]
8. Respond to call after the calling tone stops.
- [In the case that the Privacy switch is in the ON position.]
9. The continuous calling tone function is made available to any station when its Privacy switch is in the ON position. Depressing any key ([1]~[9], [0], [∗] or [∗]) other than the **PTT** key or picking up the handset of the station called causes the continuous calling tone to stop and puts the station in the conversation mode.

Note.

The sound volume of the loud speaker may be adjusted by means of the 2-stage volume selector (VOL.) switch.



< Making a call >



1. For hands-free conversation, touching the  key makes a call to the designated other station whether the Privacy switch on your station is in the ON position or OFF position.
2. When you wish to use the handset, pick it up, then touch dial the  key to make a call or reverse the order.
3. Start conversation after the calling tone stops.
4. When you hear a busy tone that indicates the party you call is on another line, you can camp on the line by simply waiting. As soon as the line becomes free, your call is automatically connected.
5. In the event that the party you are calling does not respond and the continuous calling tone is still heard from your station, or when the station of that party is in the Privacy mode and the Privacy tone is sounded, you can break in on the calling tone by continuously depressing the  key to make a voice call through the station speaker of the called party.
6. During hands-free conversation, when the person you are talking to is in a high noise level area,
 - (1) Pick up the handset to talk or (2) depress the  key continuously for one-way conversation to that party. As long as the  key is depressed, your voice has dominance, and releasing the  key will reverse the one-way conversation from that party to you.
7. To terminate the conversation, hang up the handset or depress the  key.

< Responding to a call >

[In the case that the Privacy switch is in the OFF position.]

8. Respond to call after the calling tone stops.

[In the case that the Privacy switch is in the ON position.]

9. A brief Privacy tone will sound from your station each time it receives an incoming call and all incoming calls are refused. To respond, depress the  or  key or pick-up the handset while the line is still connected between your station and the station calling. These 2 busy stations are, however, automatically disconnected from the speech path after approximately 10 seconds from call establishment if no response is made by you.

Note.

The sound volume of the loud speaker may be adjusted by means of the 2-stage volume selector (VOL) switch.

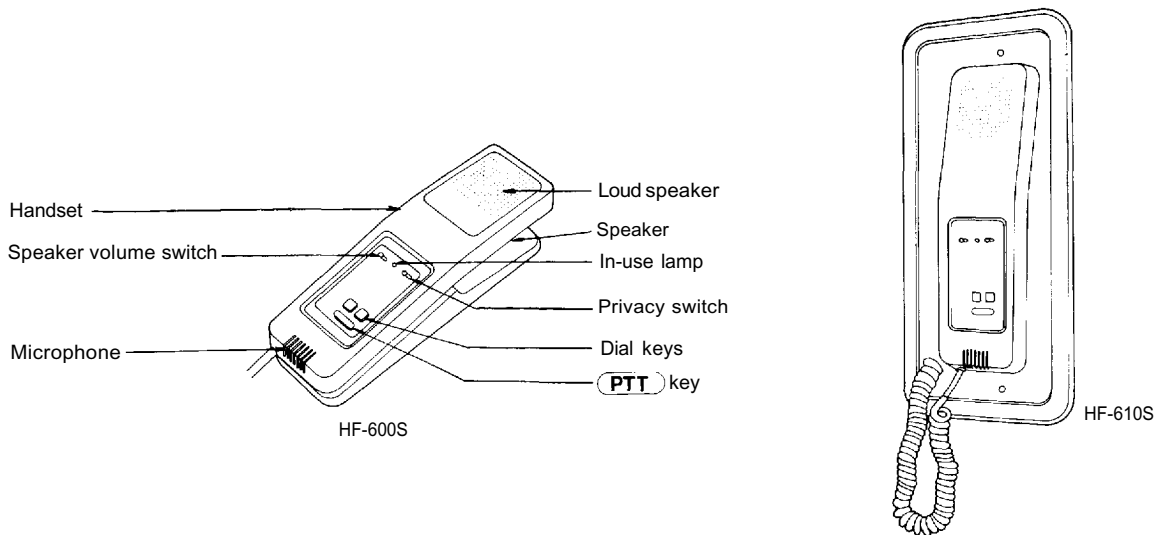

< Making a call >

1. For hands-free conversation, touching the  key makes a call to the designated other station whether the Privacy switch on your station is in the ON position or OFF position.

[In the case that the Privacy switch is in the OFF position.]

2. When you wish to use the handset, pick it up, then touch dial the  key to make a call or reverse the order.

[In the case that the Privacy switch is in the ON position.]

3. Picking up the handset makes a call to the designated other station.



-
4. Start conversation after the calling tone stops.
 5. When you hear a busy tone that indicates the party you call is on another line, you can camp on the line by simply waiting. As soon as the line becomes free, your call is automatically connected.
 6. In the event that the party you are calling does not respond and the continuous calling tone is still heard from your station, you can break in on the calling tone by continuously depressing the **PTT** key to make a voice call through the station speaker of the called party.
 7. During hands-free conversation, when the person you are talking to is in a high noise level area,
 - (1) Pick up the handset to talk or (2) depress the **PTT** key continuously for one-way conversation to that party. As long as the **PTT** key is depressed, your voice has dominance, and releasing the **PTT** key will reverse the one-way conversation from that party to you.
 8. To terminate the conversation, hang up the handset or depress the  key.

< Responding to a call >

[In the case that the Privacy switch is in the OFF position.]

9. Respond to call after the calling tone stops.

[In the case that the Privacy switch is in the ON position.]

10. The continuous calling tone function is made available to any station when its Privacy switch is in the ON position. Depressing the  or  key or picking up the handset of the station called makes the continuous calling tone stop and puts the station in the conversation mode.

Note.

The sound volume of the loud speaker may be adjusted by means of the 2-stage volume selector (VOL) switch.

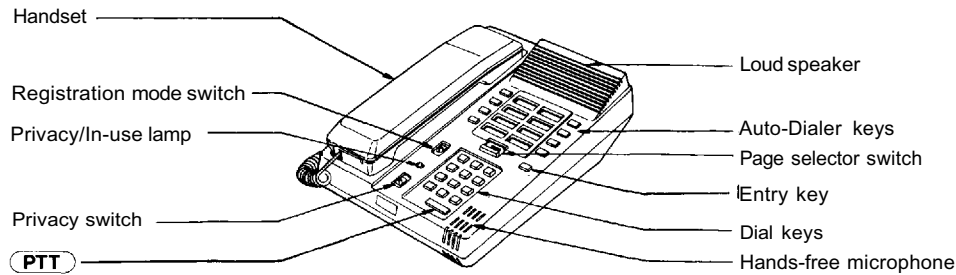

< Making a call >

1. Place the auto-dialer registration (REGISTER) switch in the OFF position.
2. A maximum of 16 single digit dialing numbers including station numbers, personal numbers and paging zone number may be programmed into the built-in auto-dialer.

(16 registrations are possible with 8 keys by changing over the Page selector switch)

You can not only call any station by touch dialing the station selector key but also you can make a call to up to 16 specific, pre-registered stations by depressing the station selector key or by single digit dialing the auto-dialer key of this station.

Note.

1. For programming the auto-dialer, please refer to the operation manual of the HF-660M.
2. The sound volume of the calling tone can be adjusted by means of the 3-stage selector (SP VOL) switch.
3. For instructions on how to call and respond without using the auto-dialer, please refer to the information as to the HF-600M/610M.

<How to make Registration at Auto-Dialer>

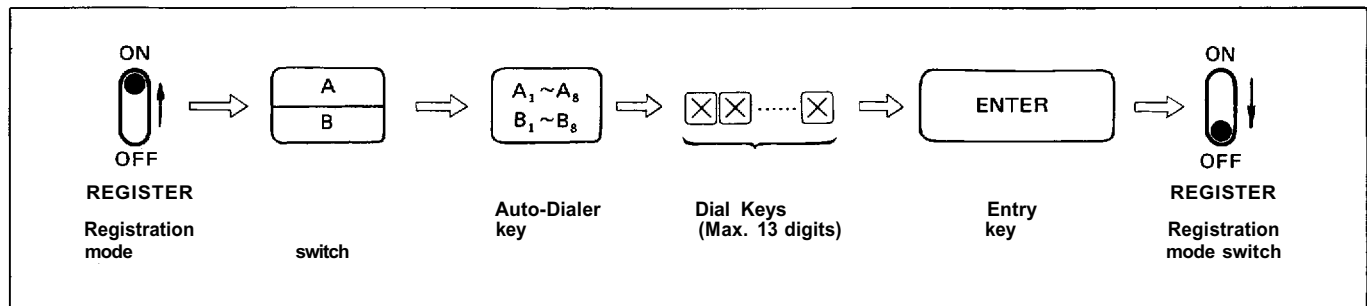

1. Place the registration mode switch (**REGISTER**) in the ON position.
A lamp turns to green and a confirmation tone is heard.
2. Place the page selector switch in either **A** or **B** position.
3. Press any one of the auto-dialer keys (**A₁ ~ A₈**, **B₁ ~ B₈**), which is to be registered.
4. Register the station or other numbers to be registered by pressing the dial keys (**1 ~ 9**, **0**, *****, **#**). A maximum of 13 digits on each auto-dialer key may be registered.
5. Press the entry key (**ENTER**). The confirmation tone is again heard and registration is completed.
6. Repeat the procedures described in (2) through (5) each time registration is made.
7. To cancel the registration, press the auto-dialer key (**A₁ ~ A₈**, **B₁ ~ B₈**) and the Entry Key (**ENTER**).
8. Place the registration mode switch (**REGISTER**) in the OFF position. The lamp goes out and the normal speech mode will resume.

Automatic Line Release

When, in dialing, all of the numbers are not dialed within 5 seconds, the station is automatically disconnected from the speech path and dialing cannot be completed. In this instance, the dialing process will have to be repeated from the beginning.

This function has been adopted to speed up traffic processing and to improve the availability of speech path.

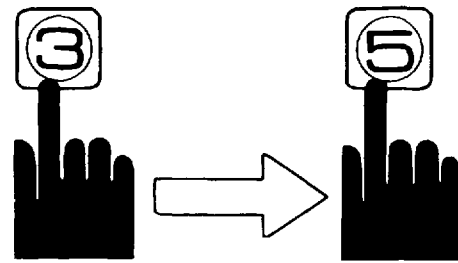

Within 5 sec

Camp-On-Busy

When the party you are calling is on another line, by simply waiting you automatically "Camp-On" the line. (Busy tone sounds continuously.) As soon as the line is freed, you will be automatically connected.

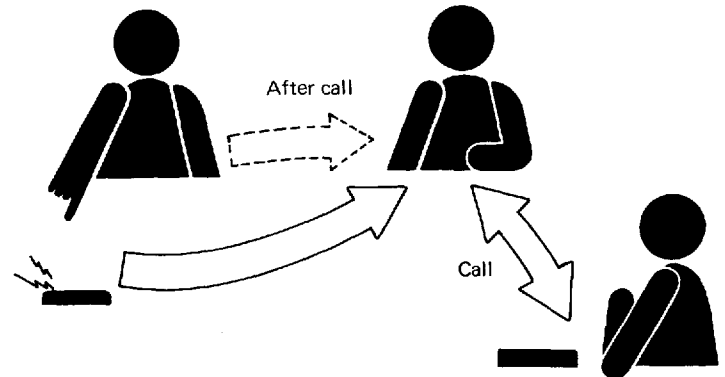

Privacy

PV Type

Shift Privacy Switch to ON.



When a party does not wish to accept incoming calls, this function may be employed to refuse them. With the Privacy switch in the ON position, a continuous privacy tone will be sounded in the station making the call, and at the same time, a brief Privacy tone will sound in the station called, indicating a call attempt is being made.

It is possible to call the other party from the station in the Privacy mode but Remote Response (PTT) is impossible from that station.

Shift Privacy Switch back to the left.



To restore a station in the "Privacy" mode to a normal condition, and thus ready to receive calls.

- Note: 1. A call received while the station is in the Privacy mode may be accepted if the Privacy function is immediately cancelled, (see Camp-On Privacy)
2. With a station that incorporates the Secretary Transfer function, the Privacy switch is used to activate the Secretary Transfer function, (see Secretary Transfer)
3. During the above "Privacy" mode, while the calling station has the (PTT) bar depressed, the privacy tone stops and the caller can transmit a oneway message.

When the (PTT) bar is released, the normal "Privacy" mode to be resumed.

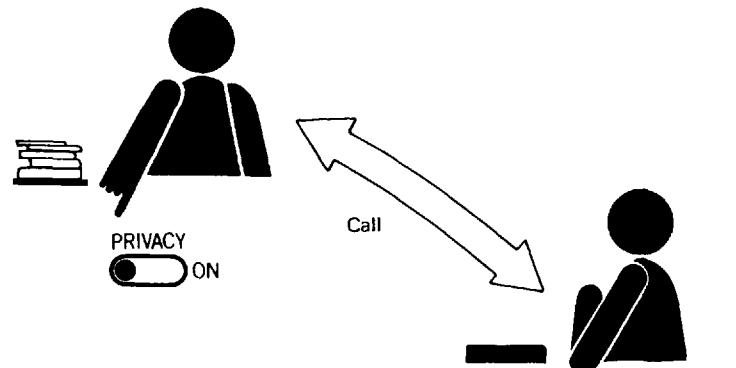
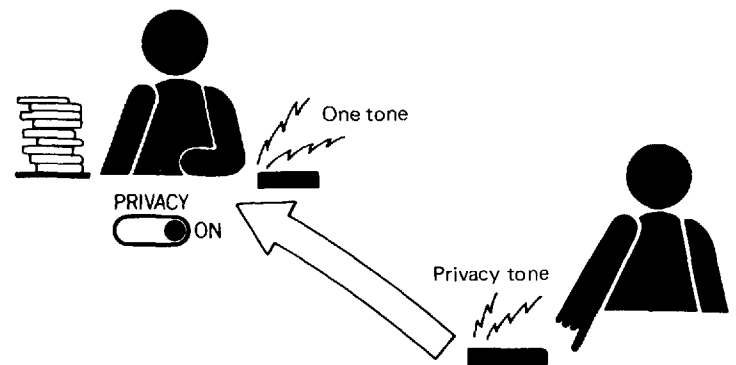

When the party you are calling has his station on Privacy mode, by simply waiting you will automatically "Camp-On" the line. (Privacy tone sounds continuously.) As soon as the Privacy mode is released, or as soon as he one-touch dials any of the keys (1~9, *, #), or, as soon as he picks up a handset of his station, you will be automatically connected.

This function is cancelled automatically if the station in the privacy mode may not accept the call within approximately 10 seconds.

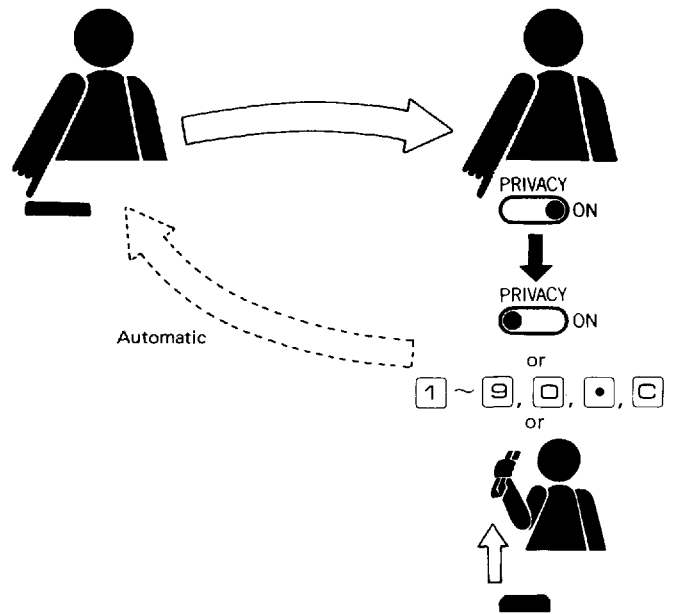

Press-To-Talk

This function is activated when the PTT (Press-To-Talk Bar)

is continuously depressed after dial tone confirmation or during hands-free conversation. This allows one-way conversation from the party depressing the function key. When the key is released, one-way conversation is reversed.

Employed when a person in a high noise level area is called by a person in a quiet area, or when no particular response is required, or when simple announcements are made. In such cases, one-way conversation flow can be used.

One-way conversation is activated while the Press-To-Talk bar is continuously depressed.

As long as the Press-To-Talk bar is depressed by either party, the voice of the party using this function has dominance. When the key is released, the other party has dominance.

One-way conversation is reversed when the Press-To-Talk bar is released.

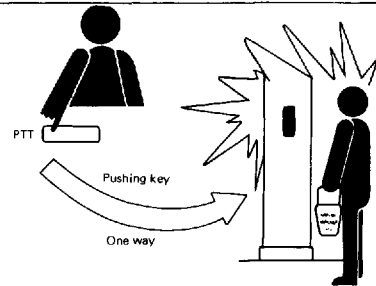

If both parties depress the Press-To-Talk bar, the voice of the party who depresses the bar last will have dominance.

Depress the



to return to ordinary hands-free 2-way conversation

Note.

One-way conversation is impossible even if the PTT bar is depressed as far as either party or both parties involved pick up a handset.

Talk Back

First, call the "Talk-Back" station as in a normal call.

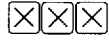

("Talk-Back" station)

The Calling tone will sound and the message is transmitted.



In this case, while the calling station has the Press-To-Talk bar depressed, the caller can transmit a one-way message.



When this bar is released, the "Talk-Back" station can give a one-way message to the caller.

This function is convenient for stations that normally only receive calls and do not have to call other stations.

Calling "Talk-Back" Station



("Talk-Back" Station)

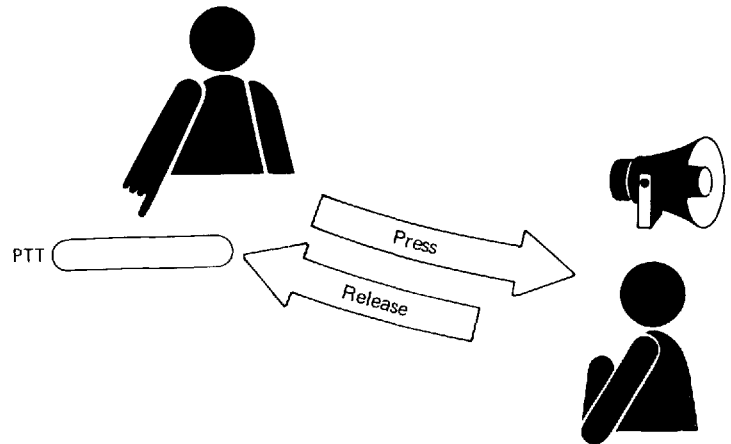

Single Digit Dialing

Single digit registration

Register in advance as follows:

• 6 0 X X X	Confirmation tone	Single digits of station number
Station number		
• 6 0 1 X X X	Confirmation tone	Single digit of personal number
Personal number		
• 6 0 • 8 X X	Confirmation tone	Single digit of paging call
Paging zone		
• 6 0 • 0	Confirmation tone	Single digit of All-call paging response
• 6 0 X X X X	Confirmation tone	
Any four digits		
• 6 0 X X X	PTT Confirmation tone	
Any three digits		
• 6 0 X X	PTT Confirmation tone	
Any two digits		

Single digit dialing

When required, dial



and the registered number will be called automatically.

Note:1. Single digit registration can be cancelled by registering your assigned station number.

2. Any function dialing with long operation may be shortened by Single Digit Dialing.

Example: Single digit Combination paging Dial

0 1, and • 8 0 1 is called automatically.

• 8 0 1 Combination paging

|| Single digit



3. One-shot make output may be operated even in the event every link is not free. But it may not be operated in single digit dialing if all links are busy.

4. Single digit registration is not available from any substation programmed by No.200 programming, even if its line is connected with master station.

Master Sub Relationship

Master/Substation associations are set up by using station #200 as the programming station. Once these relationships have been established, substations can then contact their designated master stations by simply touch dialing



If TL-600S Handset substation is used, substations can be connected to their designated master stations by simply picking up a handset. (Only applicable to [NP Type] system)

With respect to this function, the stations in the system are divided into two categories; master stations and substations. Any master station can be connected to any other station in the system. However, substations can initiate calls only to specific master stations. This is done by single touch dialing, and will only connect the substation to one specific master.

Several substations can be programmed under this station to connect with a single specified master station.

To register single digit dialing, touch dial



substation number

Single digit dialing from that master to a specific substation is then accomplished by touch dialing



Programming a master station for Single Digit Dialing of a substation number under this function is programmed in the same manner as other single digit dialing, and results in one touch dialing from master to substation.

Note.

Single digit registration is not available from any substation programmed by No.200 programming, even if its line is connected with master station.

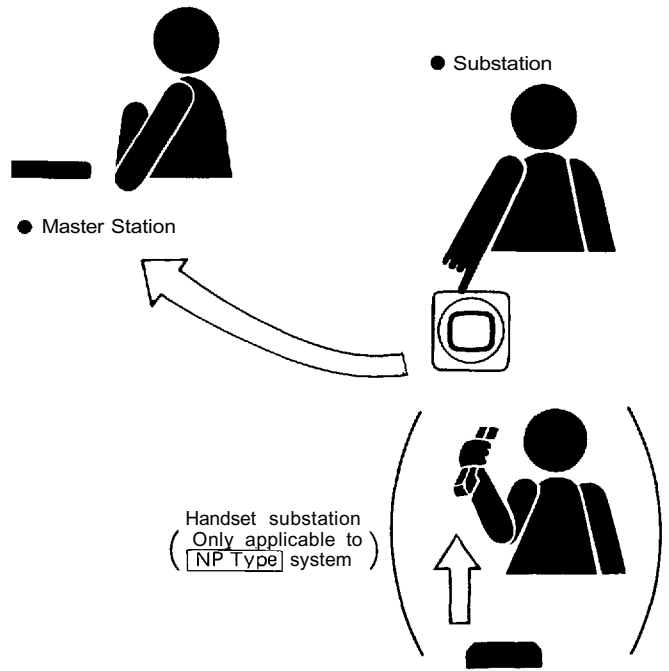

● Single Digit Registration of Substation

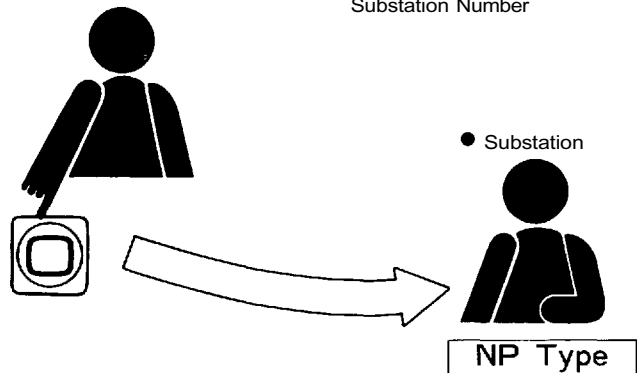
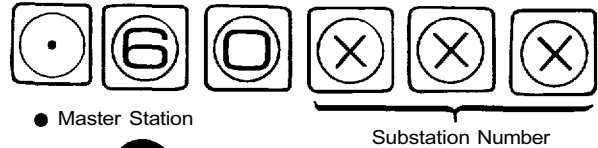

Automatic Access To Paging

Once programming has been set up for the purpose of this function.

A paging call may be made from specific Handset Substations to the registered zone by simply picking up a handset. Refer to Fig. 1

A specific Handset substations may respond to the paging call by simply picking up a handset. Refer to Fig. 2

Note.

Single digit registration for Handset Substation as well as No.200 programming is required for this function at the time of installation.

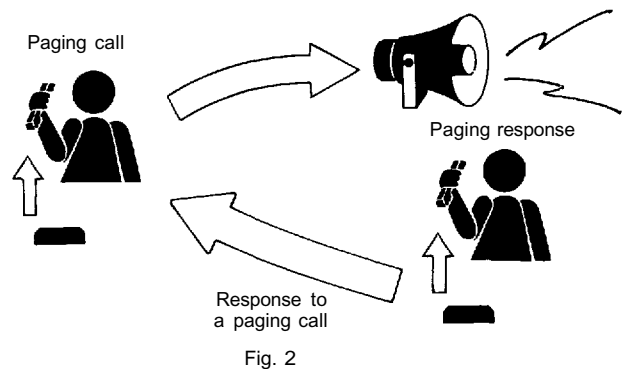
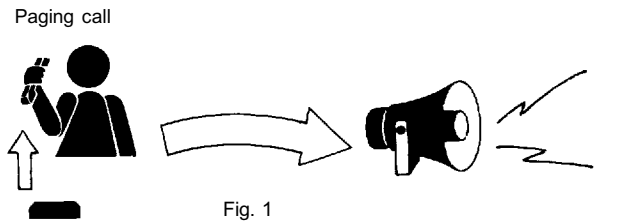

Personal Number Call

A personal number may be registered at any master station which the person to whom the number is assigned expects to be. A party wishing to receive personal number calls at a specific station may register his number at that station by touch dialing

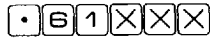

Personal Number.

Those who are frequently away from their assigned station, as well as those who share a single station may be assigned a "Personal" 4-digit number which may be programmed to any master station in the system. This personal number, which is completely independent of station numbers, may be programmed at any master station, and any previous programming of that same number at any other station is automatically cancelled. When the party calling has dialed the number to which he wishes to speak, the call is then routed to the station at which the Personal Number was last registered. The numbers which may be assigned in this group are 1000 through 1499.

Personal number program cancellation can be done at any station by merely dialing:

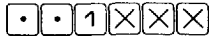

Personal Number

When anyone having a personal number leaves the office, he merely cancels the programming of his personal number. With the personal number cancelled, any incoming calls to that number will be answered by a dial tone, indicating that he is not available.

Note.

The maximum number of the Personal Number remains same even if the number of exchange to be connected is increased to 2 or 3.

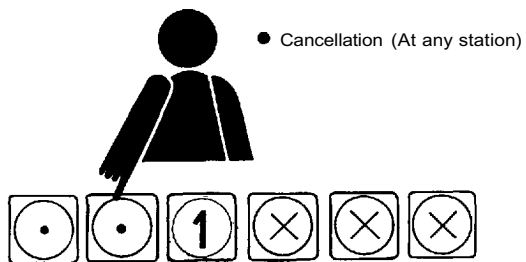
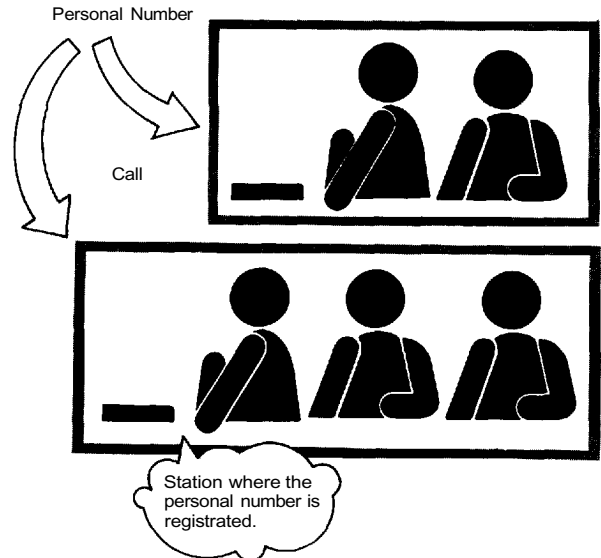
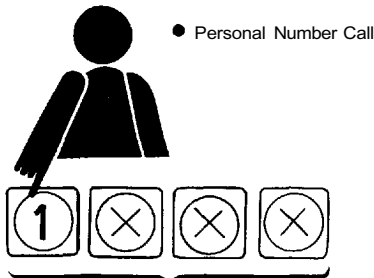
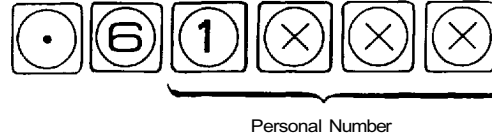

Continuous Calling Tone

When a specified station receives a call, the calling tone continues until

1 ~ 9, 0, * or #
(except **PTT** key)

is depressed by this party.

1. When calls cannot be answered immediately or when it is difficult to hear a normal calling tone due to high background noise, the station should be provided with the continuous calling tone function. There is no limit to the number of stations that may be equipped with this function, but a No.200 registration must be completed.
2. When the caller depresses the **PTT** bar while the continuous calling tone sounds, he can talk to the person called by one-way. When the **PTT** bar is released, the continuous calling tone returns.
3. During two-way conversation, each party presses the **PTT** bar to talk and releases the **PTT** key to receive the other party. (Press to Talk)

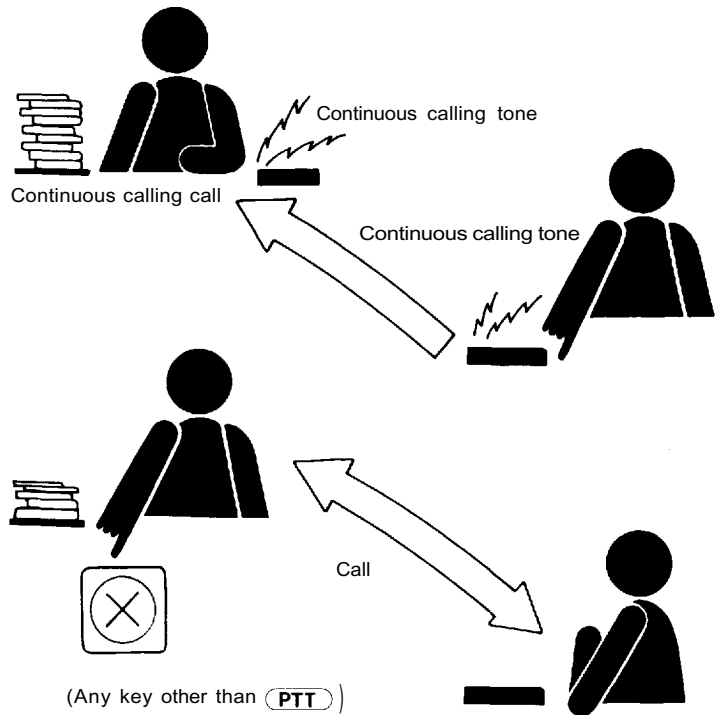

Note.

1. In the event of the system without Privacy function (NP Type system), stations with Privacy switch in the ON position are called by a continuous calling tone. By No.200 programming, this continuous calling tone function may also be made available to the system having Privacy function (PV Type system) and to industrial type of station model HF-650M.
2. Two (2) different continuous calling tones may be employed in
 - (1) stations used in "NP" type system having a standard function of "continuous calling tone".
 - (2) specific stations provided with a "continuous calling tone" function by station No. 200 programming.

< Comparison of continuous calling tones >

Type of system	Type of station (Specific station provided with "continuous calling tone" function by station No.200 programming)	Nature of calling tone	
		Privacy switch in OFF position	Privacy switch in ON position
"PV" Type	Non-programmed station (standard)	Single "trill" calling tone (Call is put through immediately after calling tone)	Privacy tone
	Programmed station	Continuous calling tone	Privacy tone
"NP" Type	Non-programmed station (standard)	Single "trill" calling tone (Call is put through immediately after calling tone)	Continuous calling tone
	Programmed station	Continuous calling tone	Continuous calling tone
Responding to a call made by continuous calling tone		Depress any dial key other than PTT key.	1. Depress only dial key other than PTT key. 2. Pick up a handset. 3. Shift Privacy switch to OFF.

Remote Response

This feature is available only among stations programmed for this purpose. When a station at which no one is present is called by means of a continuous calling tone, remote response to that call can be made by pressing the (PTT) key from any other station programmed for this function.

Note.

1. This function is only possible when a station is called by a continuous calling tone.
2. When this function is used from a station with the Privacy switch ON, press the (PTT) key, after lifting a station handset or after shifting the Privacy switch to OFF.

◆ **Programming the remote response group**

Establish the remote response group of stations and designate a specific station within the group as a temporary "Master station" and the rest as "Substations".

The Master station registers the number of his own station as follows.



Master's number

Each of "Substation" within the group registers the "Master" 's number by dialing



Master's number

Note.

Make sure that the temporarily designated master always registers his own station number at time of programming.

◆ **Cancelling remote response program**

Touch dialing at each "Substation"



His own Substation number

cancel Is the Remote response program.

Note.

When 2 or 3 exchanges are connected by tie-line, select the Remote response group within the stations connected to the same exchange.

● **Dial operation for Remote response**

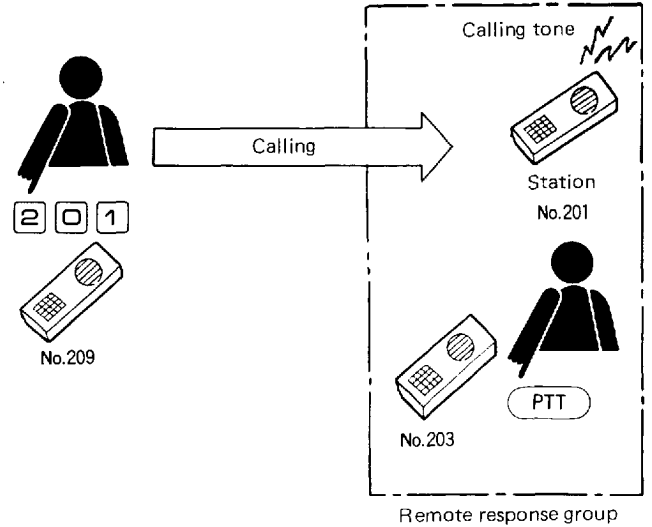

● **Conversation after Remote response**

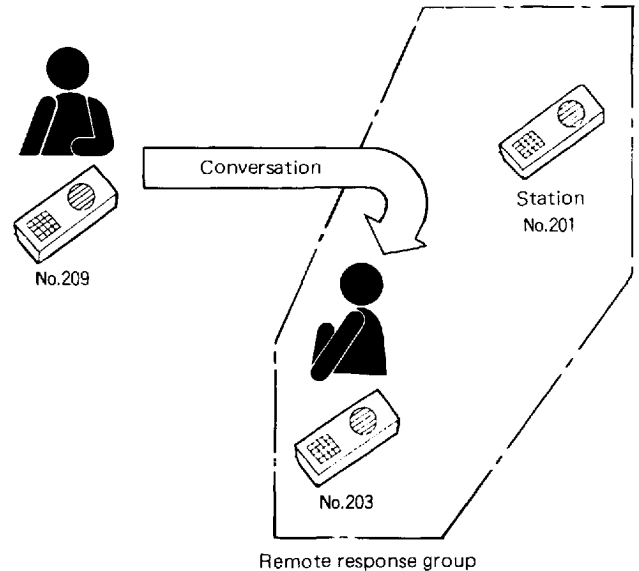

● **Programming the remote response group (Example)**

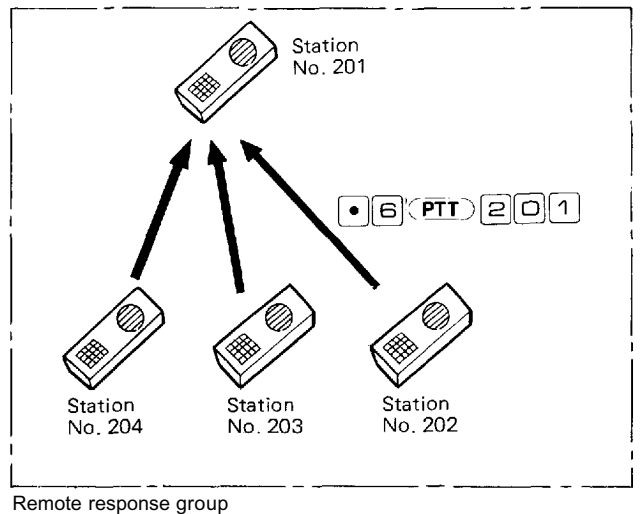

Call Transfer

Call Transfer from Called Station

During the conversation, first dial



(the Station Number of the person the call is to be transferred to).

The original call is then held and the holding tone is transmitted to the other party, while the third party is called and asked whether he will accept the call. If he agrees to accept the call, dial

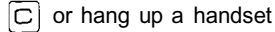

and the transfer will be completed.

This function allows called party to transfer that call to another station. The party to whom the call is to be transferred, may be called using either the Station Number, the Personal Number or through Single Digit Dialing.

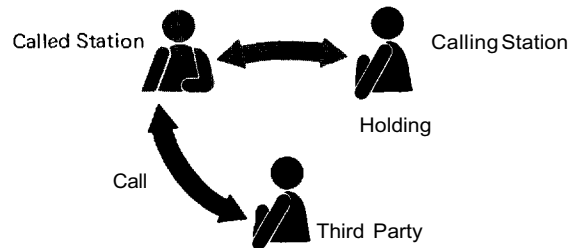
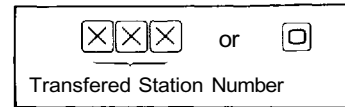
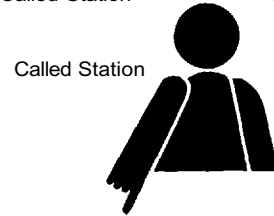
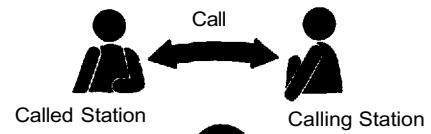

Call Hold and Call Back from Calling or Called Station

During the conversation, first dial



the Station Number of the third party.

The other party is then placed on hold as the third party is called. Upon completion of the conversation with the third party,

the party called touch dials the



key

or the third party touch dials the



key

or the third party replaces a handset.

This allows the original conversation to resume.

The Transfer function is combined with the Call Holding function.

When two parties are talking, either one can be temporarily placed on hold to permit the calling of another station. The conversation with the third party over, the original conversation can be resumed.

The third party can be called using either the Station Number, his Personal Number or through Single Digit Dialing.

● Transfer

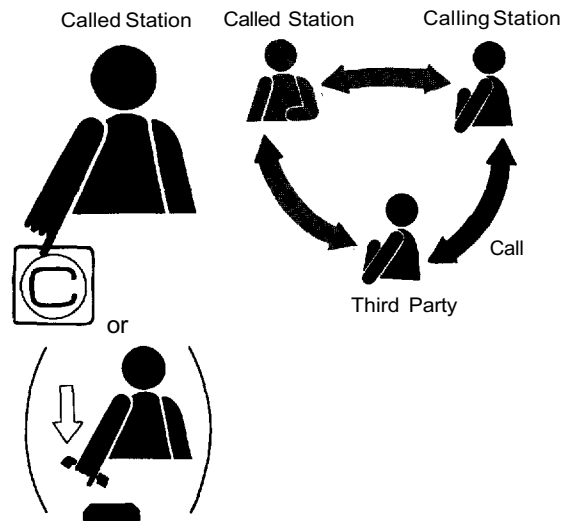

Note.

When 2 or 3 exchanges are connected by tie-line, an original call can be transferred only to the third party who shares the same exchange with the party who transfers the call.

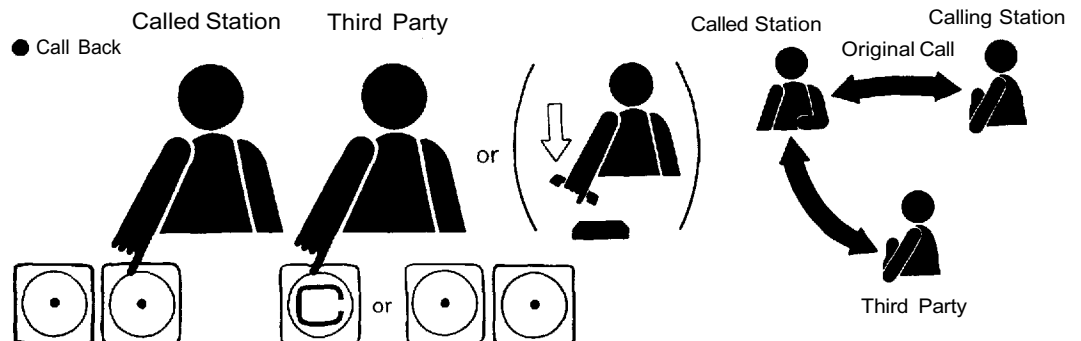

Paging during Normal Calls

A paging call can be made by a called party of an existing call to a third party, the third party's response accepted while the original call is on hold, and the original call resumed when the response call has ended. Press



and the desired zone number. This puts the original call on hold and makes the External PA and or Station paging call. Then, press to restore the original call, and wait for the response to the paging call. When the response is received, press , or replace the handset, and the original call goes back on hold allowing the second call to be taken. When the second call is completed, press and the original call can be resumed.

Note.

1. With adoption of the selective functions "Call Transfer" and "Paging", this function is allowed to activate.
2. When 2 or 3 exchanges are connected by tie-line, paging during a normal call is only possible within the paging zones allocated to the exchange to which a station making the paging is connected. And All-call paging during a normal call is impossible.

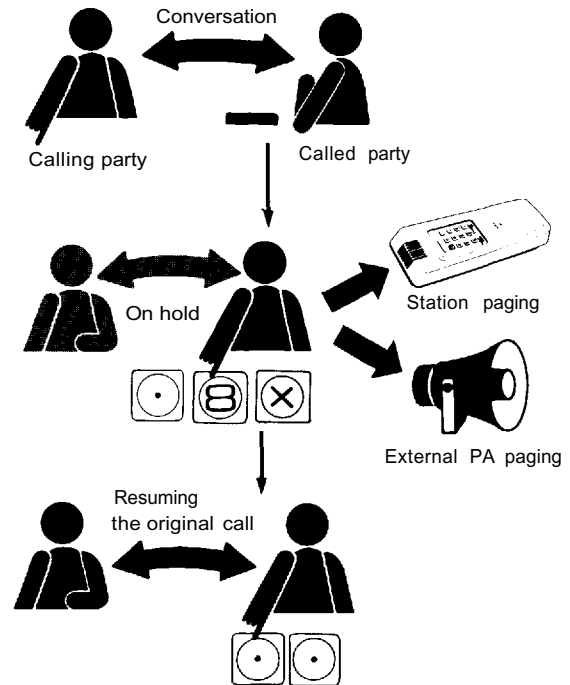

Group Hunting

When the party you are calling is on another line, your call is automatically rerouted to another station which is programmed from the beginning.

When the party to whom the call is rerouted is also on another line, the call can further be rerouted to the other station by programming.

Note.

1. To use this function, station No.200 programming of the station number(s) to which the call is to be transferred must be set up in the exchange. Place a DIP switch for Group Hunting in the ON position and make Group Hunting programming, so that this function can be programmed.
2. The combined use of this function with the "Secretary Transfer" function makes the system more functional. When "Secretary Transfer" function is employed, setting the Privacy switch to the ON position allows any incoming call to be automatically transferred to the other stations even when one is absent.
3. If station No. 200 programming is made so that the call can be rerouted to the station which is called first when the other stations registered are busy, then any call can be transferred automatically to another station. Similarly, the original call can be rerouted one after another in the "Secretary Transfer".
4. When 2 or 3 exchanges are connected by tie-line, select the station to which the call is to be transferred within the same exchange group.

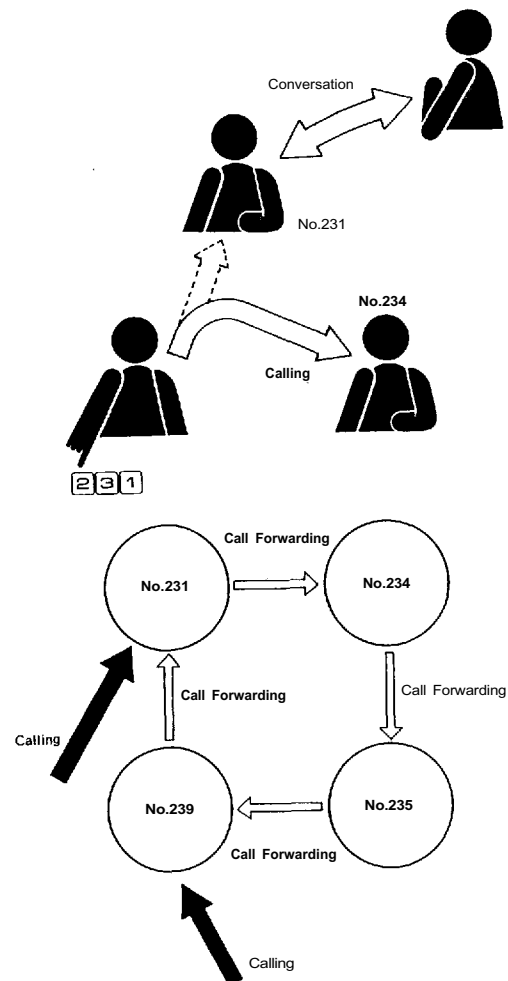

Secretary Transfer

This function is only available when a specified station is programmed for this purpose with use of Station #200 in the programming mode. Automatic transfer of incoming calls by an executive to his secretary is accomplished by placing the Privacy Switch on his station in the ON position.



This function allows a secretary to accept all incoming calls placed to an executive.

For the executive to accept calls directed to his station once the automatic secretary function has been programmed by station #200, he simply moves the privacy switch to the left, or OFF position.



It is also possible for the executive to accept calls at his station.

There is no limit to the number of Executive/Secretary pairings except by the number of available number combinations within a given system.

When a secretary who is already programmed for this function wishes another secretary to accept all incoming calls directed to an executive, station No. 200 programming of another secretary should be set up in the exchange. Then, the calls can be rerouted to another secretary if the executive and the secretary first registered place their Privacy switches in the ON position. It is also possible to transfer the call in a daisy chain method.

Note.

When 2 or 3 exchanges are connected by tie-line, set up a Secretary/Executive association within a group of stations connected to the same exchange.

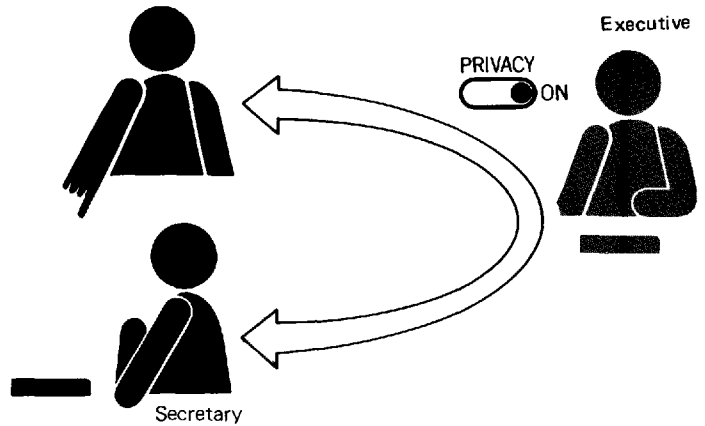

Digit the executive station.

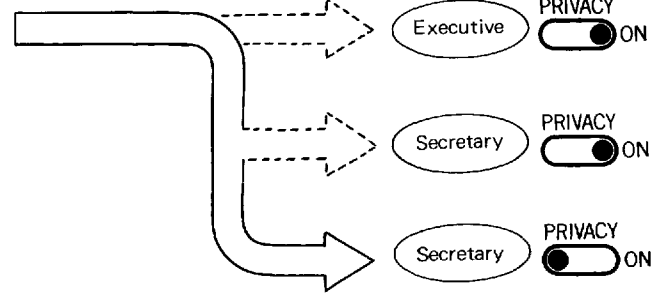

Secretary Transfer and Call Transfer

PV Type

Adoption of the selective function "Transfer" allows rerouting of the call transferred to the secretary back to the executive's station.

When the secretary answering a call touch dials



Executive's station number

the privacy tone sounds continuously at both ends of the line, while the call is held. The call holding tone is transmitted to the calling station. If the executive shifts the privacy switch to the left position, or if he depresses any of the keys other than the PTT key (□~□, □, □, □), or picks up a handset he can talk with the secretary. If the call held is to then be transferred back to the executive's station, the secretary is to touch dial □, or to hang up a handset, and the original calling station will be connected to the executive's station.

Secretary Transfer and Call Transfer using Single Digit Dialing

Adoption of the selective functions "Transfer" and "Single Digit Dialing" allows simple retransfer of the call transferred to the secretary back to the executive's station.

Touch dial



Executive's station number

at the secretary's station in advance. When the call transferred to the secretary has to be transferred back to the executive, the secretary simply touch dials



at her station. This sets the privacy tone sounding continuously at both ends of the line while the call is held. If the call is to be transferred back to the executive's station, the secretary touch dials

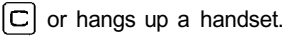

The calling station will then be connected to the executive's station.

Reply from the executive, the secretary touch dials



This will then return the secretary to the original call.

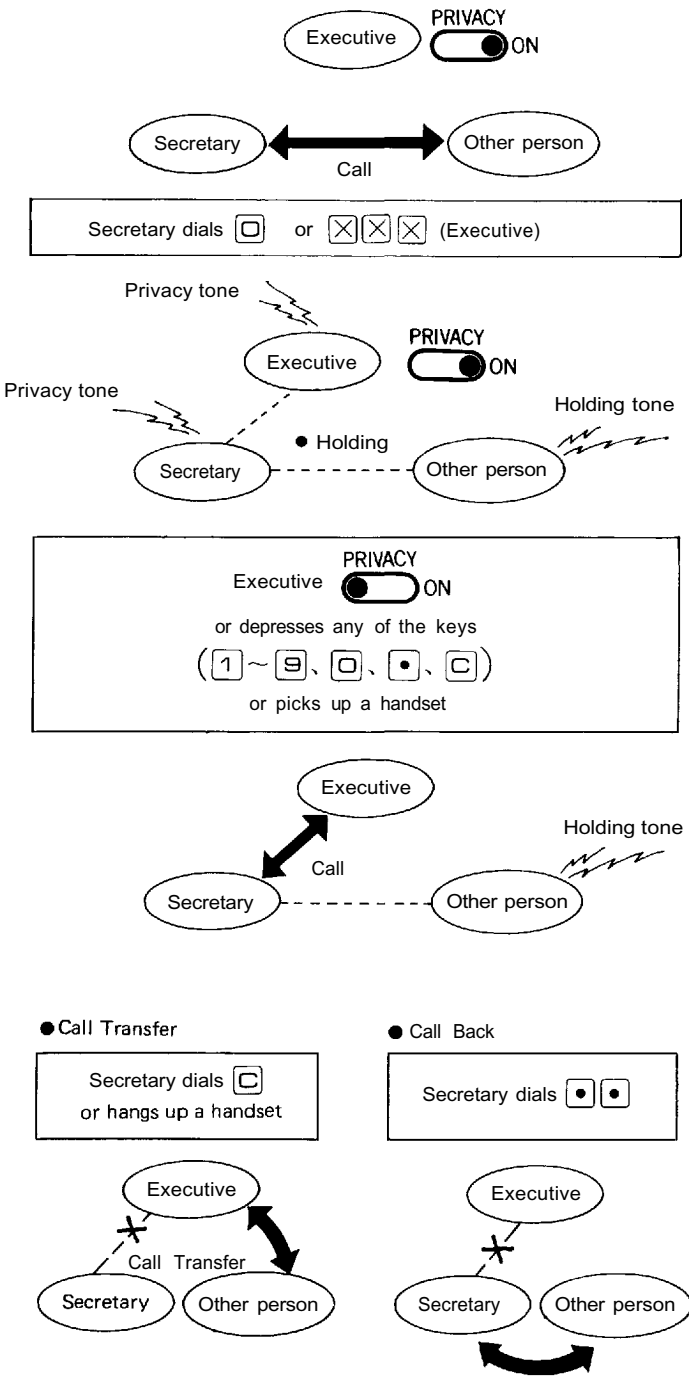

Secretary Transfer and Call Transfer

Adoption of the selective function "Transfer" allows rerouting of the call transferred to the secretary back to the executive's station.

When the secretary answering a call touch dials

Executive's station number

the continuous calling tone sounds at both ends of the line, while the call is held. The call holding tone is transmitted to the calling station. If the executive shifts the privacy switch to the left position, or if he depresses any of the keys other than the PTT key (~, , , , , or picks up a handset he can talk with the secretary. If the call held is to then be transferred back to the executive's station, the secretary is to touch dial , or to hang up a handset, and the original calling station will be connected to the executive's station.

Secretary Transfer and Call Transfer using Single Digit Dialing

Adoption of the selective functions "Transfer" and "Single Digit Dialing" allows simple retransfer of the call transferred to the secretary back to the executive's station.

Touch dial 6

Executive's station number

at the secretary's station in advance. When the call transferred to the secretary has to be transferred back to the executive, the secretary simply touch dials

at her station. This sets the continuous calling tone sounding at both ends of the line while the call is held. If the call is to be transferred back to the executive's station, the secretary touch dials or hangs up a handset.

The calling station will then be connected to the executive's station.

Reply from the executive, the secretary touch dials

This will then return the secretary to the original call.

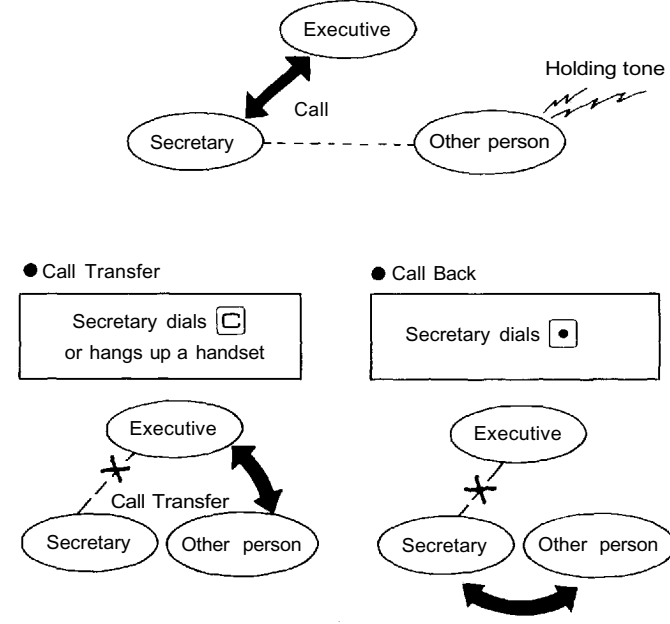
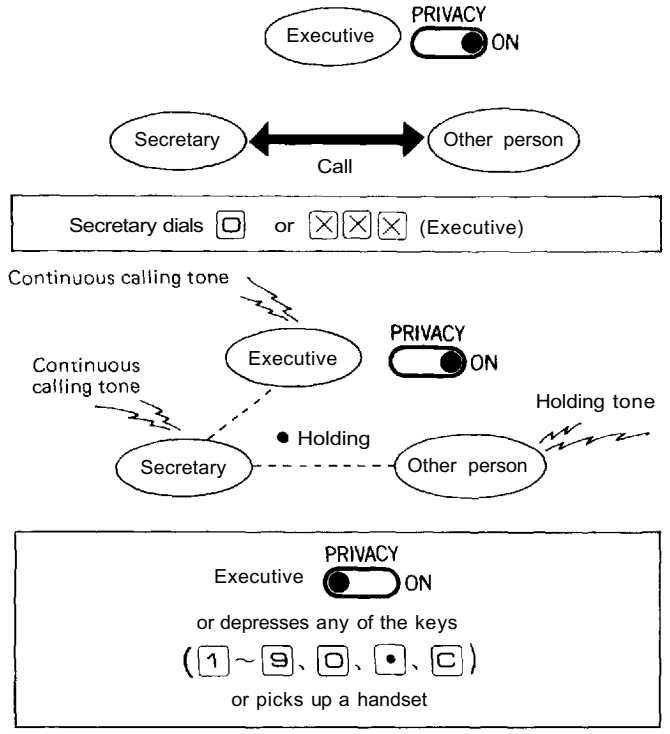

Executive Priority (Highest Priority)

This function is available only for those stations specifically programmed for this function, with programming station No. 200. When the station called is busy, as indicated by the busy or privacy tone, dialing



sends a priority tone. This priority tone is transmitted for a few seconds and then the call is put through, terminating the original conversation.

When the called station is busy or in the Conference mode or during a paging call, this function allows forced interruption for priority conversation.

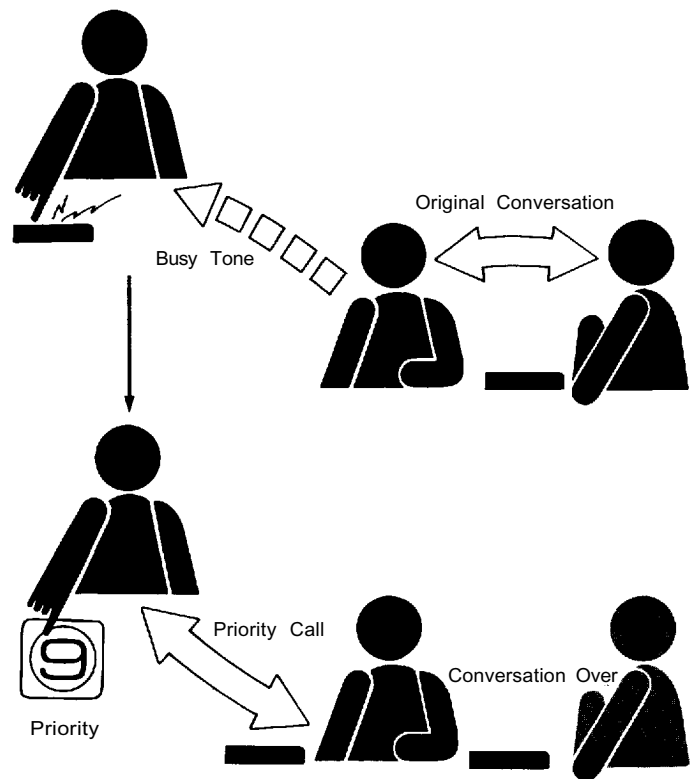

Conference

A "Hands-Free" conference call can be made with up to 4 persons. For a conference under this function the other participants may be called either through their station number, personal number or by Single Digit Dialing. Addition of stations or personal numbers (total of only 4) may be added by anyone already connected.

The person who proposes the conference may dial

• 5 XXXX

(Station Number of the 1st of the participants)

After receiving 2nd person's consent, he may then dial

XXXX

(2nd participant)

After receiving 3rd person's consent, he may now dial

XXXX

(the last participant)

At this point, the 4-man conference may begin. It is also possible for any of the 4 participants to call up any of the other participants.

A person wishing to drop out of the conference should dial

C or hangs up a handset

at his station.

Any of the participants who wish to drop out during the conference may do so as long as it's not the party who originated the conference.

The function is cancelled and the normal mode is restored when the person who arranged the conference dials

••

In the event that the calls made by the person arranging the conference are not answered or that there has been a dialing error, the function can be cancelled for restoration to the normal mode.

The conference is terminated when the party who arranged the conference dials

C or hangs up a handset

When the conference has been terminated by the party who originated it, the other participants cannot continue the conference.

- A "Hands-Free" conference call can be made with up to 4 persons.

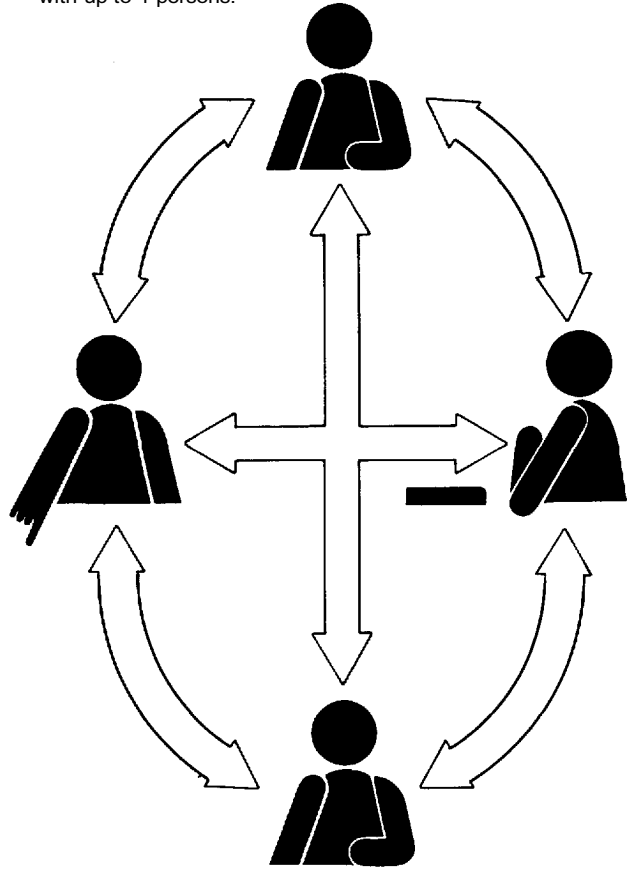

- Dialing of conference member.

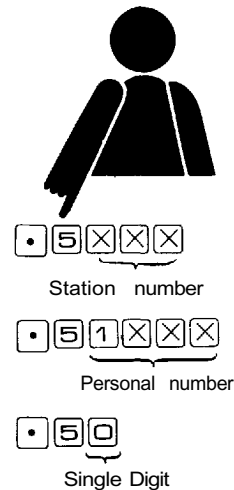

Paging

A variety of paging modes allows paging over a wide area from any master station. The paged party may respond from the nearest master station.

Paging modes include external PA systems and/or Station paging, and Zone paging is for calling a limited area and All-call paging is for calling over the entire area.

Response to a paging call may be made by means of Automatic response or Zone number dialing.

1. External PA paging and Station paging

A. External PA paging

1. Paging through external speakers is possible from any master station, with the paged party able to respond from the nearest master station.
2. External PA paging zones and all-call paging are possible up to a maximum number of 7 zones per exchange.
3. A maximum of 14 zones can be connected when 2 exchanges are tie-lined and 21 zones for 3 exchanges.

B. Station paging

1. Paging from any master station to all stations within a certain area is possible through the station speakers. But the page will not be heard at stations in use in the area.
2. Zone paging and all-call paging are possible up to a maximum number of 7 zones per exchange.
3. A maximum of 14 zones can be connected when 2 exchanges are tie-lined and 21 zones for 3 exchanges.

2. Zone paging and All-call paging

A. Zone paging (Individual zone paging).

Paging and Paging response are possible through Zone paging. The same paging zones (Exchange A: No. 1 ~ 7, B: No. 8 ~ 14, C: No. 15 ~ 21) are used for PA paging and Station paging. Therefore, both PA and Station paging calls are possible in the specific zone connected for the both paging functions.

To page, depress



Zone No. (01 ~ 21)

To respond to a zone paging, depress



Zone No. (01 ~ 21)

B. All-call paging

Paging and Paging response for External PA or station paging is possible through All-call paging. All-call paging is possible over the zones (No. 1 through 21) connected for PA or Station paging, and it is possible to make the paging response from any station. However, the station not connected to any of the paging zones is not paged. This does not necessarily mean that All-call station paging must reach all the stations.

To make a all-call paging, depress

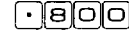

To respond, depress



3. Responding to a paging call

A. Automatic response

1. Zone paging response
Touch dialing



at the station within the paged zone permits a response to the party who placed a paging call.

In this event, No. 200 registration of the stations (consecutive station numbers) within each zone must be made.

2. All-call paging response
Touch dial



at any station and the paged party is put through to the party calling.

B. Zone number dialing

1. Zone paging response
The paged party is connected to the party calling by depressing



Zone No. (01 ~ 21)

at any station.

A response to the zone paging is possible only from a station connected to the exchange that includes the paged zone.

2. All-call paging response
Depressing



permits a response to the party calling.

How to select the paging area and make the paging call

Paging area	No.	Paging		Dialing operation		
		External PA paging	Station paging	Paging call	Response	
					Automatic response	Zone number dialing
All-call paging over the entire zones of exchanges "A", "B" and "C" *1	0	Available	Available			
Zone paging to the zone of exchange "A"	1	Available	Available	 Zone No. (01-07)		 Zone No. *3 (01-07)
	7					 Zone No. *4 (08-14)
Zone paging to the zone of exchange "B"	8	Available	Available	 Zone No. (08-14)	 *2	 Zone No. *4 (08-14)
	14					 Zone No. *5 (15-21)
Zone paging to the zone of exchange "C"	15	Available	Available	 Zone No. (15-21)		 Zone No. *5 (15-21)
	21					

Note.

- *1 When 2 or 3 exchanges are connected by tie-line but 1 or 2 of them have no built-in Paging unit (PI), All-call paging is done only over the remaining exchange(s).
- *2 A paging response is possible only from the station in the paged zone.
- *3 A paging response is possible only from the station connected to the exchange "A" (station No 200 ~ 311)
- *4 A paging response is possible only from the station connected to the exchange "B" (station No 470~ 517)
- *5 A paging response is possible only from the station connected to the exchange "C" (station No.740~ 851)

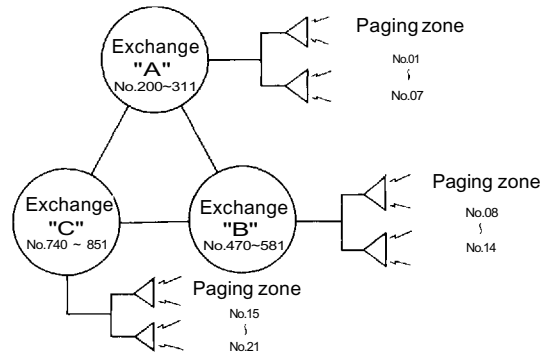

◆ Total number of stations for exchange without Paging Interface Unit (PI unit)

< The case where the tie-line system consisting of 2 or 3 exchanges has an exchange without the PI unit >

1. The case where it is necessary to make the paging call from the exchange without the PI unit to the other exchange(s).

You may not substitute the LM unit (LM 8 or LM16) for the PI unit.
EX-610: Max. 48 stations, EX-620: Max. 112 stations

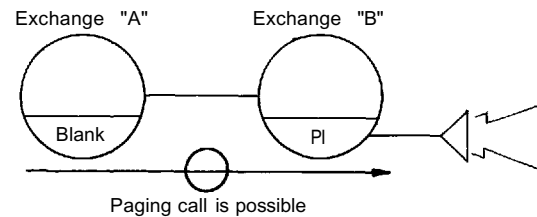

2. The case where the paging call is unnecessary from the exchange without the PI unit to the other exchange(s).

You may substitute the LM unit (LM8 or LM16) for the PI unit.
EX-610: Max. 56 stations, EX-620: Max. 120 stations

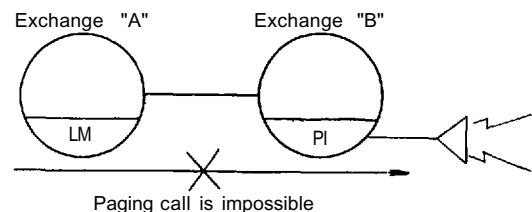

All-Call Paging and Individual Zone Paging

◆ Paging call

External PA paging to a specific zone is possible from any master station by pressing after picking up a handset.

("00" = all-call)
 (00 ~ 21)

It is possible to wait for a response in this mode, but anything said will be broadcasted over the entire zone. It is best to end the paging call by pressing

or hanging up a handset

and waiting for a response.

All-call paging of zones 1 through 21 can be done in both the External PA paging mode through an external amplifiers and speakers, and the station paging mode through the station speakers. In the event of All-call paging, the paging is done over the entire zones.

When all-call paging is initiated during zone paging, the Zone paging is interrupted and restored after the all-call paging is finished.

◆ Paging response

1. Automatic response

To respond to a paging call, go to the nearest master station and press either

(All-call paging response)
 or
 (Zone paging response)

A paging response is possible only from the station in the paged zone.

A response to All-call paging is possible from any station.

To respond to Zone paging by pressing , No. 200 registration of the stations (consecutive station numbers) within each zone must be made. Such registration is required for both external and station paging.

2. Zone number dialing

To respond to a All-call paging, go to the nearest master station and press

or

To respond to a Zone paging call, press

Zone No. 01 ~ 21

at the nearest station.

A response to the zone paging is possible only from a station connected to the exchange that includes the paged zone (Exchange "A": Zone No. 1 ~ 7, "B": No. 8 ~ 14, "C": No. 15 ~ 21). It is not impossible to respond from the station connected to the other exchange.

A response to All-call paging is possible from any station.

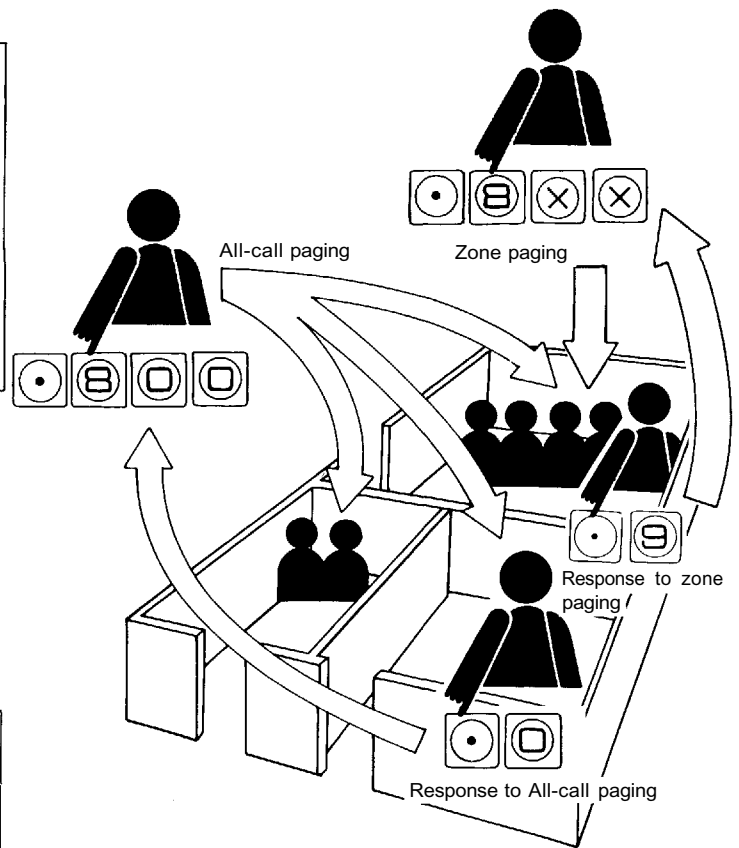

Table of stations used for individual zone paging (Example)
(In the case of "Automatic response")

	Zone numbers	First station number	Last station number
Exchange A	1	2 0 1	2 0 3
	2	2 0 5	2 0 7
	3	2 1 0	2 1 9
	4		
	5		
	6		
	7		
Exchange B	8		
	9		
	10		
	11		
	12		
	13		
	14		
Exchange C	15		
	16		
	17		
	18		
	19		
	20		
	21		

Selectable First Station Number of Each Exchange

1. The exchanges A, B and C permit the following Standard Station Numbering Schedules (Hardwired station number):

< Standard station numbering >

Type of Exchange	A	B	C
With Personal Number (Standard)	200~	470~	740~
Without Personal Number	100~	400~	700~

2. If you prefer any other station numbering schedules than those given in the above Item 1, you can have the station number series (Consecutive number) to start with any of No. 100/200/300/400/500/600/700/800/900 in the order of exchange A, B and C. (Hardwired station number)

< Example >

Type of Exchange		A	B	C
Example 1	With Personal Number	<u>3</u> 00~	<u>5</u> 00~	<u>7</u> 00~
Example 2	Without Personal number	<u>1</u> 00~	<u>6</u> 00~	<u>9</u> 00~

Programmable Station Numbering

1. This function allows the system to have "Programmable station numbers", other than the "Hardwired station numbers" by programming.
The stations not registered for "Programmable Station Numbers" remain in the original "Hardwired Station Number".
2. Each station number can be programmed in the station number series of the exchanges A, B and C that have been determined by the function of the Selectable First Station Number.

1. Numbering schedules can be changed easily by programming in stead of rewiring.
2. Numbering schedule (such as 200's, 300's, 900's) is available for convenient office differentiation, (architectural numbering). (Refer to Fig. 1)

< Fig. 1 >

Hardwired station number	Programmed station number	
2 0 1	2 0 1	} Department 1
2 0 2	2 0 2	
2 0 3		
2 0 4	3 0 1	} Department 2
2 0 5	3 0 2	

3. Normally, station numbers which are included in a station paging zone must be sequential, but programmable station numbers can be randomly included in a station paging zone. (Refer to Fig. 2)

< Fig. 2 >

Hardwired station number	Programmed station number	
2 0 1	2 0 1	} Station paging zone
2 0 2	2 3 1	
2 0 3	2 4 1	

4. Programming at station No. 200, 470 and 740 must set up in each exchange to change the station numbering.

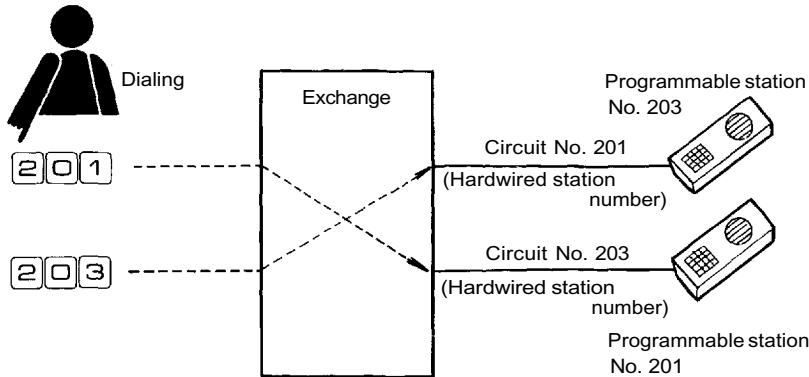

< Fig. 3 >

Hardwired station number	Programmed station number
2 0 0	→
2 0 1	2 0 3
2 0 2	→
2 0 3	2 0 1
3 2 6	→
3 2 7	→

5. "Programmable station number" series for each exchange

< Example 1 > With Personal Number

Exchange.	Hardwired station number	Programmed station number
A	200~327	200~469
B	470~597	470~739
C	740~867	740~999

< Example 2 > Without Personal Number

Exchange	Hardwired station number	Programmed station number
A	100~227	100~399
B	400~527	400~699
C	700~727	700~999

< Example 3 >

Exchange	Hardwired station number	Programmed station number
A	200~327	200~399
B	400~527	400~599
C	600~727	600~799

(Standard)

6. People operating the intercom stations need not be aware of the Hardwired station numbers. However, care must be taken when programming using station No. 200 in the exchange, as hardwired station numbers must be used for that purpose.

Group Blocking

Function (A)

The system can be grouped or divided into a maximum of 6 groups of stations with consecutive station numbers by exchanges "A", "B" and "C". Different station groups cannot call each other.

[Example 1]

< Exchange "A" >

Fig. 1

Group 1 No.201-209		
Group 2 No.210-219	Group 3 No.220-249	Group 4 No.250-279

< Exchange "B" >

Fig. 2

Group 1 No.470-479	
Group 2 No.480-489	Group 3 No.490-499

< Exchange "C" >

Fig. 3

Group 1 No.740-759	
Group 2 No.760-769	Group 3 No.770-799

Function (B)-1

The group connected to the same exchange can call and/or be called by any other group(s) within the same exchange area.

Function (B)-2

Only one pair of groups can call each other across the tie-lined exchange. The tie-line link of each exchange (4 links) forms a group (T_L and T_H) like stations. The groups No.1 through 6 connected to the same exchange can call exchange by programming in tie-line links T_L (group No. 7) and T_H (group No. 8).

[Example 2-1] Fig. 4

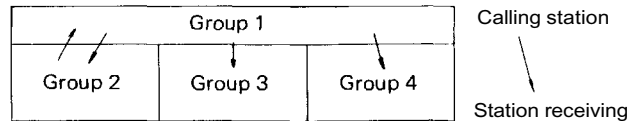

[Example 2-2] < 2 exchanges tie-lined > Fig. 5

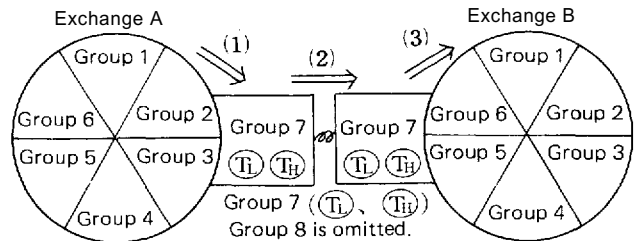

< 3 exchanges tie-lined > Fig. 6

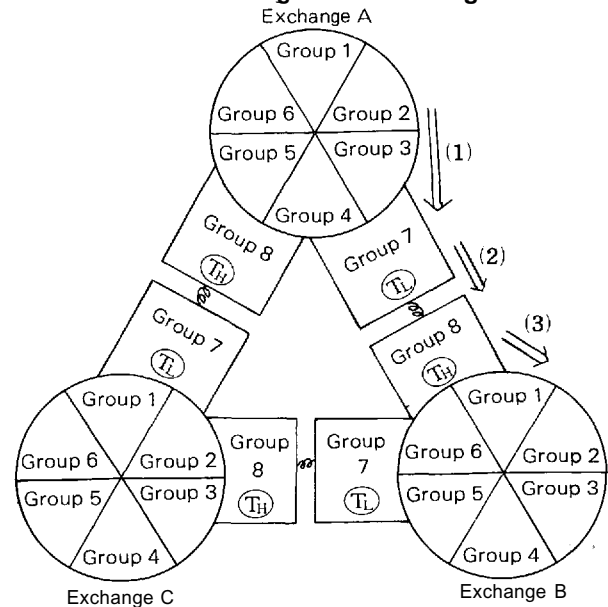

Explanation of < 3 exchanges tie-lined > (Fig. 6)

- 1) The call can be made from Group No. 2 of exchange "A" to tie-line links T_L of exchange "A". (1)
- 2) Connect tie-line links T_L of exchange "A" to tie-line links T_H of exchange "B". (2)
- 3) The call can be made from tie-line links T_H of exchange "B" to group No. 1 of exchange "B". (3)
- 4) Thus, the call is allowed to go through from Group No.2 of exchange "A" to Group No. 1 of exchange "B".

Function (C)

The paging zone number (All-call, individual zones No.1 ~ 14 for 2 exchanges and No.1 ~ 21 for 3 exchanges) which each group of each exchange can call is programmable. (No distinction is made between external PA and Station paging.) Paging to the paging zones of the other exchange is also programmable.

Note.

When the paging call is made, the group of stations to which the response is made is restricted by Function B. Function B permits the normal station call in the direction of the arrows. Its paging response can be made in the opposite direction of the arrows. (Refer to Fig. 4 and Fig. 8)

< Example of Paging response >

When the programming is set up for the normal station call as is shown in Fig. 4, the paging response is only possible in the direction of the arrows of Fig. 8.

[Example 3] Fig. 7

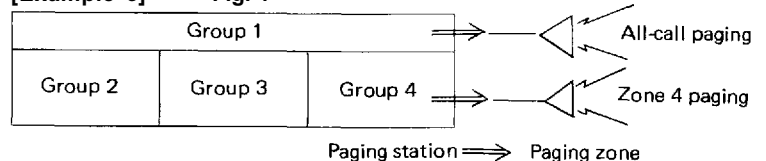

[Example 4] Fig. 8

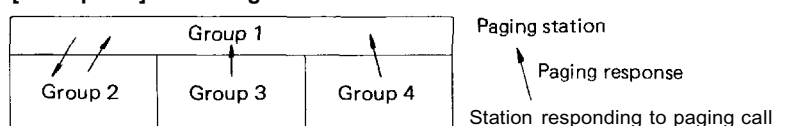

Example of Group Blocking registration

To use this function, station No. 200 programming (No.470 programming or No.740 programming) of the allocated station number, group, paging zone, etc., must be set up in the exchange.

1. Example of conversation and paging

To make this example of Group Blocking available for the system, the following programming at steps 2 through 4 must be set up in each exchange.

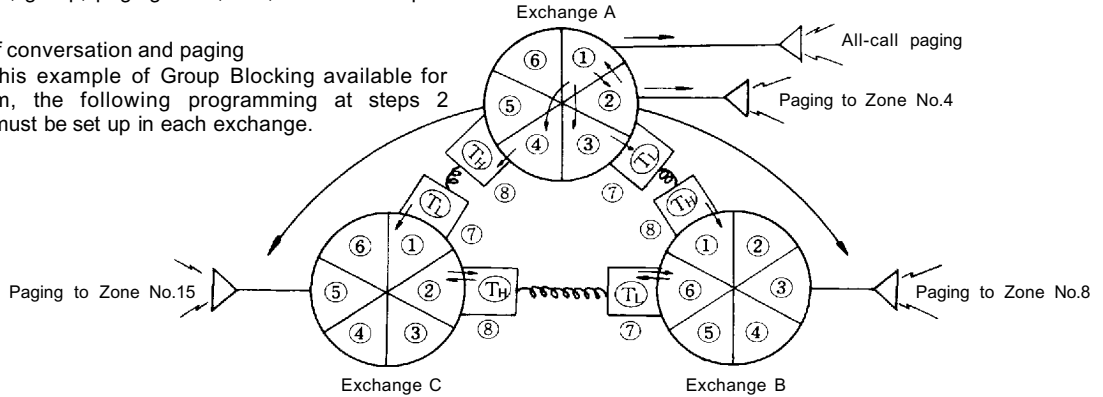

2. "No. 200 programming" in Exchange A

Function registration (A)		Function registration (B)								Function registration (C)																									
Station for each group Group No. of calling station		Group No. of station receiving call								Paging zone of station receiving call																									
										All-call	Zone No.																								
First station No.	Last station No.	1	2	3	4	5	6	7	8	X	00	01	02	03	04	05	06	07	08	09	10	11	12	13	14	15	16	17	18	19	20	21			
2 0 1	2 0 9	1	⊙	⊙	⊙					⊙	⊙																								
2 1 0	2 1 9	2	⊙	⊙						⊙	⊙																								
2 2 0	2 4 9	3		⊙	⊙					⊙	⊙																								
2 5 0	2 7 9	4			⊙	⊙				⊙	⊙																								
		5				⊙	⊙			⊙	⊙																								
		6					⊙	⊙		⊙	⊙																								
Tie-line links (T ₁) A → B		7																																	
Tie-line links (T ₂) A → C		8																																	
Station not in group		X	⊙	⊙	⊙	⊙	⊙	⊙	⊙	⊙	⊙	⊙	⊙	⊙	⊙	⊙	⊙	⊙	⊙	⊙	⊙	⊙	⊙	⊙	⊙	⊙	⊙	⊙	⊙	⊙	⊙	⊙	⊙	⊙	

3. "No.470 programming" in Exchange B

Function registration (A)		Function registration (B)								Function registration (C)																										
Station for each group Group No. of calling station		Group No. of station receiving call								Paging zone of station receiving call																										
										All-call	Zone No.																									
First station No.	Last station No.	1	2	3	4	5	6	7	8	X	00	01	02	03	04	05	06	07	08	09	10	11	12	13	14	15	16	17	18	19	20	21				
4 7 0	4 7 9	1	⊙							⊙	⊙																									
4 8 0	4 8 9	2	⊙							⊙	⊙																									
4 9 0	4 9 9	3		⊙	⊙					⊙	⊙																									
		4			⊙	⊙				⊙	⊙																									
		5				⊙	⊙			⊙	⊙																									
		6					⊙	⊙		⊙	⊙																									
Tie-line links (T ₁) B → C		7																																		
Tie-line links (T ₂) B → A		8	⊙																																	
Station not in group		X	⊙	⊙	⊙	⊙	⊙	⊙	⊙	⊙	⊙	⊙	⊙	⊙	⊙	⊙	⊙	⊙	⊙	⊙	⊙	⊙	⊙	⊙	⊙	⊙	⊙	⊙	⊙	⊙	⊙	⊙	⊙	⊙	⊙	

4. "No. 740 programming" in Exchange C

Function registration (A)		Function registration (B)								Function registration (C)																											
Station for each group Group No. of calling station		Group No. of station receiving call								Paging zone of station receiving call																											
										All-call	Zone No.																										
First station No.	Last station No.	1	2	3	4	5	6	7	8	X	00	01	02	03	04	05	06	07	08	09	10	11	12	13	14	15	16	17	18	19	20	21					
7 4 0	7 5 9	1	⊙							⊙	⊙																										
7 6 0	7 6 9	2	⊙							⊙	⊙																										
7 7 0	7 9 9	3		⊙	⊙					⊙	⊙																										
		4			⊙	⊙				⊙	⊙																										
		5				⊙	⊙			⊙	⊙																										
		6					⊙	⊙		⊙	⊙																										
Tie-line links (T ₁) C → A		7																																			
Tie-line links (T ₂) C → B		8	⊙																																		
Station not in group		X	⊙	⊙	⊙	⊙	⊙	⊙	⊙	⊙	⊙	⊙	⊙	⊙	⊙	⊙	⊙	⊙	⊙	⊙	⊙	⊙	⊙	⊙	⊙	⊙	⊙	⊙	⊙	⊙	⊙	⊙	⊙	⊙	⊙		

Note.

- ⊙ Indicates that registration is not necessary.
- X Indicates that the station is not within the group.

Programmable Restricted Access for Stations

Stations which can use the 6 groups of following functions must be programmed, so as to restrict access to those functions by those stations not programmed.

1. All-call paging

• 8 0 0

2. Conference

• 5 X X X

Station number

3. General purpose control

Mode 1 (One-shot make output)

• 3 X X

00 ~ 49

4. General purpose control

Mode 2 (Make/break output)

• 3 5 X X

00 ~ 99

• 3 6 X X

00 ~ 99

5. General purpose control

Mode 3-A (8 selectable make output)

• 3 7 X Y

1 ~ 9 1 ~ 8, 0 (Clear)
Unit No. Condition No.

General purpose control

Mode 3-B (Decimal output)

• 3 8 X Y

1 ~ 9 0 ~ 9
Unit No. Condition No.

6. General purpose control

Mode 4 (4 decimal digits output)

• 3 9 X Y Y Y Y

1 ~ 9 0000 ~ 9999
Unit No. 4-digits

Note.

For a conference call, only those stations allowed to use the conference link can dial.

The other members of the conference need not be allowed conference access.

Selectable Calling Tone

The duration of the calling tone can be set for either 0.2 second (single note tone) or 0.3 second (warble tone). It is also possible to have the station without any calling tone.

Note.

1. The duration of the continuous calling tone is impossible to change.
2. Different modes of the duration of the calling tone may not be employed in each station within the same system.

Selectable Paging Pre-Announcement Tone Duration

The duration of the all-call and zone paging tones can be set for either 2 seconds ("long") or 1 second ("short"). It is also possible to have the system without any paging pre-announcement tone.

Time-Out of Conversation

It is possible to limit the conversation duration to one through ninety-nine minutes in the unit of one minute in order to improve speech path availability. A hurry-up tone is sounded in both the calling and called stations approximately 10 seconds before the busy stations are automatically disconnected from the speech path.

Time-Out of Paging Call

This function is employed to prevent the unnecessary line occupation as a result of a paging party's failure to depress the key after a paging call establishment. The paging call is automatically cancelled after a certain period of time, which may be set at one through ninety-nine minutes in the unit of one minute, with a hurry-up tone transmitted to the paging station approximately 10 seconds prior to the automatic disconnection. When the paged party responds, the conversation is automatically cut off after the duration set by the Time-out of conversation function.

In/Out Annunciation

The in/out annunciation indicators can be turned on or off from any master station by using the personal number registering procedure.

When a personal number registration is made at a station, by dialing

• 6 1 X X X

1000~1499 (personal number)

the personal number is registered at that station and the personal number lamp on the in/out indication panel is turned on.

Personal number call

By dialing

1 X X X

1000~1499 (personal number)

from any station, the call is put through to the station registered with the personal number.

Cancelling personal number and turning off in/out annunciation.

By dialing

• • 1 X X X

1000~1499 (personal number)

from any station, the personal number is cancelled and the personal number lamp on the in/out indication panel is turned off.

1. The maximum number of in/out annunciation windows is 500.
This maximum number remains same even if the number of exchange to be connected is increased to 2 or 3.
2. The in/out indication panel must be used with the Data Transmitting and Receiving Units (DT-E11 and DR-B61).

In/out indication panel

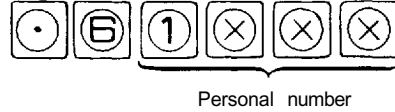
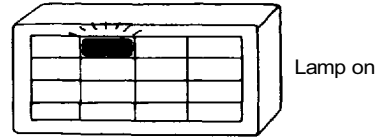

In/out indication panel

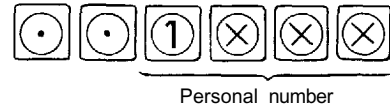
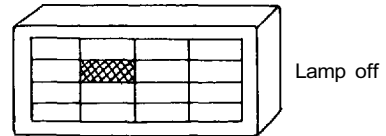

Calling Party Indication (Lamp Type)

A one station/one lamp type calling party indication panel can be provided for certain specified stations (eight stations or eight groups of stations)

The system can also be divided into a maximum of 8 groups of stations (consecutive station numbers) so that each group may have the calling party indication panels which are common within the group. The party making the call is indicated even if the call is made to any station in the group.

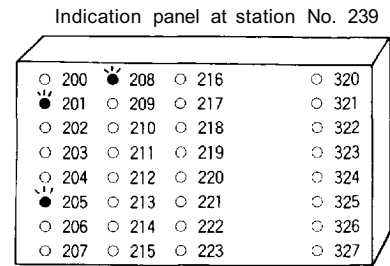

<Calling station memory>

It is also possible to equip the system with the "Calling station Memory" function. Adopting this function causes the calling party's lamp on the indication panel to keep on lighting even if he cancels the call when the called party is on other line or in Privacy mode.

< Indication mode without calling station memory >

1. A lamp of the calling station comes on and goes out when the conversation is over.
2. When the call is made during conversation or privacy mode, a lamp of the calling station comes on and goes out when the calling station cancels the call.

< Indication mode with calling station memory >

1. The lamp at the station receiving the call comes on when a call is made and goes out when the conversation is completed.
2. When a call (camp-on-busy) is made to the busy or the privacy station (with the privacy switch on), the lamp of calling station comes on. The lamp will not go out even if the original call is cancelled.
3. The lamp goes out after the conversation is cancelled.
4. Dialing



without placing a call causes all lights to go out. *1

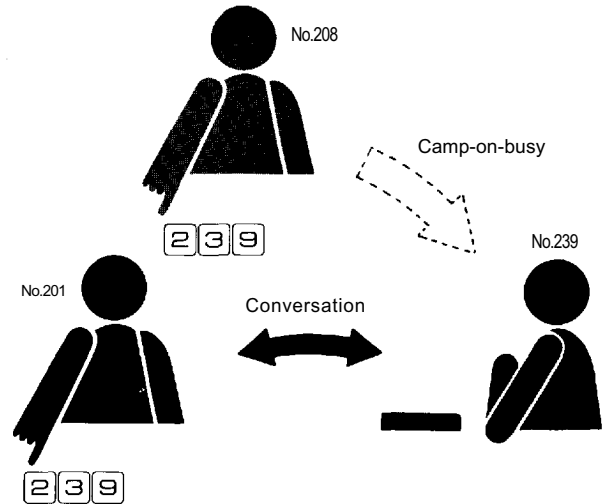

Note.

*1. In the case of Handset Master station TL-600M, lift a station handset and confirm that a dial tone is heard. Press after cancelling the dial tone by pressing .

1. The maximum number of calling stations is 120. When 2 or 3 exchanges are connected by tie-lines, the party who is calling through the other exchange is not indicated.
2. The indication panel must be used with the Data Transmitting and Receiving Units.
3. No. 200 programming of stations or groups of stations for which a calling party indication panel is provided must be set up in exchange "A", No. 470 programming in exchange "B" and No. 740 programming in exchange "C".

Example of registration

Indication panel	First station number	Last station number
1		
2	239	239
3		
4		
5	251	255
6		
7		
8		

1. Station No. 239 has the indication panel No.2.
2. The group of stations No. 251-255 is provided with the indication panel No. 5.

< Calling party selection >

1. When there are more than 2 incoming calls to a busy station, the calling parties' lamps on the indication panel come on. The called party may select the calling party he wishes to respond to by touch dialing plus (desired calling party's number). In this event, the original conversation is finished.
2. In the event that a station in the busy mode receives a call that is indicated on the indication panel, by touch dialing (the calling party's number), the called party is put through to the calling party, while the original conversation partner is placed on "hold" temporarily. (Refer to "Call Transfer" and "Call Back".)

Indication panel at station No. 239

<input type="radio"/> 200	<input checked="" type="radio"/> 208	<input type="radio"/> 216	<input type="radio"/> 320
<input checked="" type="radio"/> 201	<input type="radio"/> 209	<input type="radio"/> 217	<input type="radio"/> 321
<input type="radio"/> 202	<input type="radio"/> 210	<input type="radio"/> 218	<input type="radio"/> 322
<input type="radio"/> 203	<input type="radio"/> 211	<input type="radio"/> 219	<input type="radio"/> 323
<input type="radio"/> 204	<input type="radio"/> 212	<input type="radio"/> 220	<input type="radio"/> 324
<input checked="" type="radio"/> 205	<input type="radio"/> 213	<input type="radio"/> 221	<input type="radio"/> 325
<input type="radio"/> 206	<input type="radio"/> 214	<input type="radio"/> 222	<input type="radio"/> 326
<input type="radio"/> 207	<input type="radio"/> 215	<input type="radio"/> 223	<input type="radio"/> 327

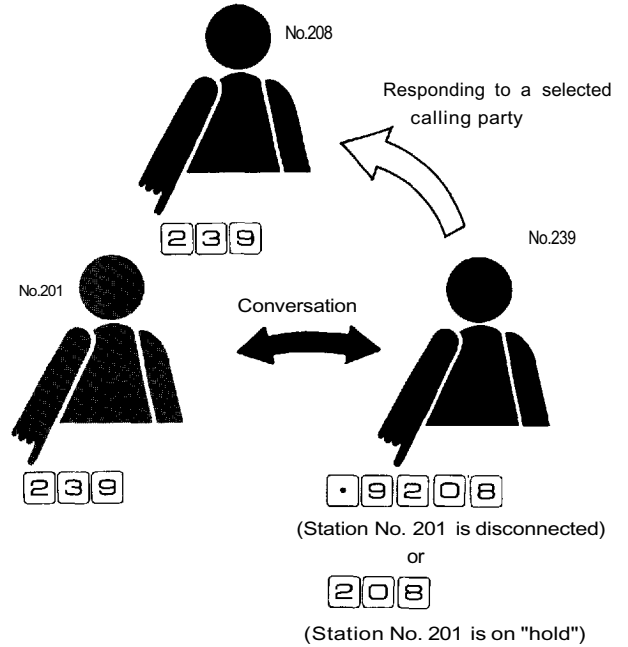

Pocket Pager

The system can be connected with usual type Pocket pager using the interface with Make/break relay output.

1. Dial



(00 ~ 63, Pager No.)

and the pager is called after confirmation tone is heard.

2. When

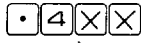

(00 ~ 63, Pager No.)

is dialed by the party called from the nearest master station, it is possible to respond a call to the station.

Note.

1. Once a receiver is called from one station and a response is waited for, camp-on-busy will result for other callers. But, if a response to the call is not received within 3 minutes, the terminal can be called from a new calling station.
2. If the pager is called after confirmation tone is heard, a calling station is disconnected from the speech line and waits for a response while the relay for pager transmission is kept in the Make position till a response is made. The station which waits for a response can be called from the other stations.
3. The other stations can call the other pagers while one station makes a call and is waiting for a response.
4. Dialing (pager number that is called) cancels calling the pager if the wrong number has been pressed.
5. When the exchanges are connected by tie-lines, it is only possible to call the pager from the stations connected to the exchange "A" for stations No. 200 through 327. A pager response can be made from any station.

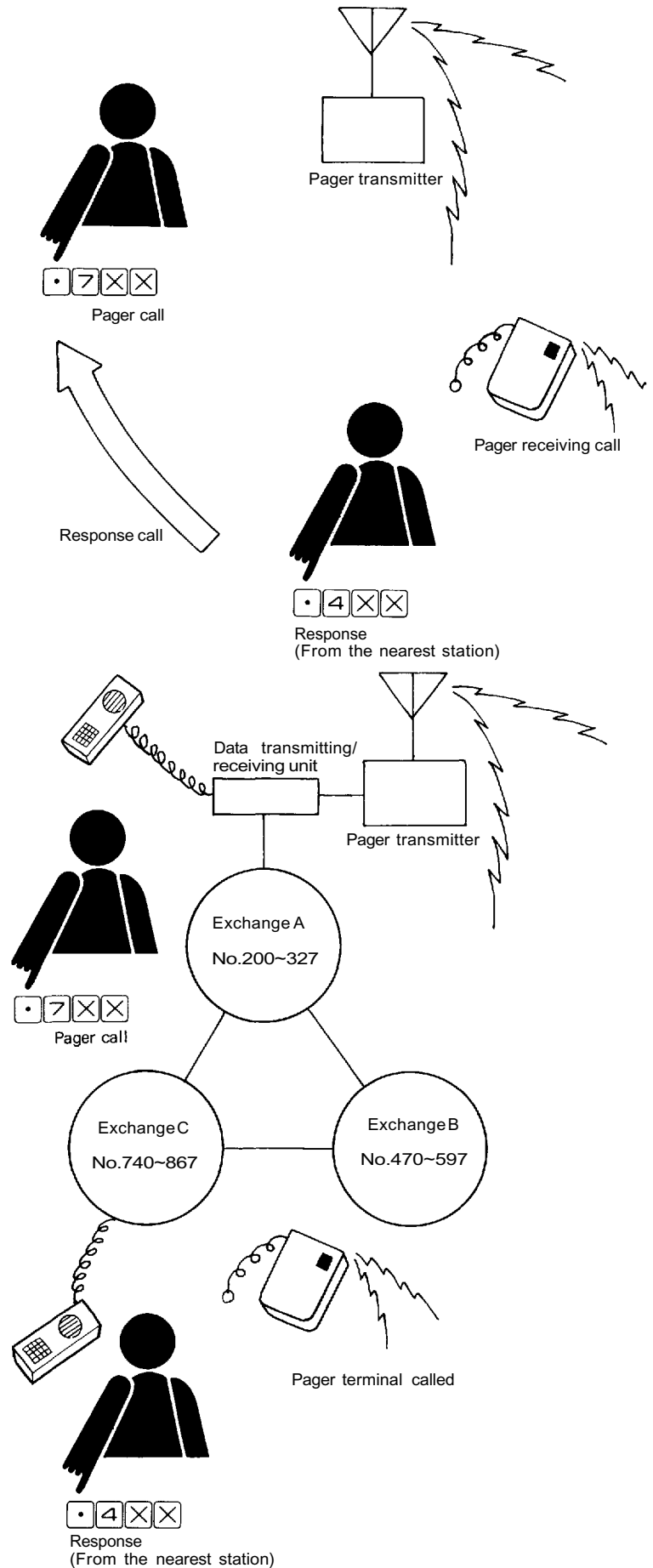

General Purpose Control

Station may be restricted from access to this function. This function can control other equipments by employing the Data Transmitting and Receiving Units.

Select the required type of output.

(Mode 1) One-shot make output (50 contacts)

Dial

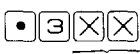

 00 ~ 49

and the relay output is made for 1 to 2 seconds.

Example: Door remote and VTR control

Note: Operation performed even when all links are busy.
But One-shot make output by Single digit dialing cannot be accomplished when all links are busy.

(Mode 2) Make/break output (100 contacts)

Dial



 00 ~ 99

and the make output is sent out.

Dial



 00 ~ 99

and the break output sent out.

Example: In/out annunciation, Prescription annunciation.

(Mode 3) 8 selectable make output and/or decimal output

(A) 8 selectable make output (9 units)

Dial



 1 ~ 9 1 ~ 8, 0 (Clear)
 Unit No. Condition No.

and one of the 8 relay outputs is made. "Clear" operation makes all 8 relays **break**.

Example: Destination indication, room condition indication, ITV control, VTR control

(B) Decimal output

Dial



 1 ~ 9 0 ~ 9
 Unit No. Condition No.

and the condition is indicated numerically.

Example: Destination indication, room condition

(Mode 4) 4 decimal digits output

Dial



 1 ~ 9 0000 ~ 9999
 Unit No. 4 decimal digits

and 4 decimal digits are indicated.

Example: Prescription annunciation

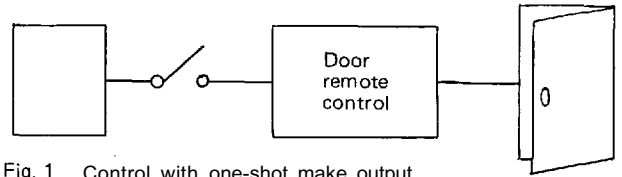

Fig. 1 Control with one-shot make output

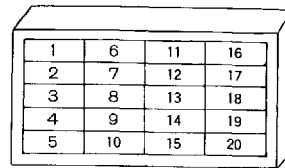

Fig. 2 Lamp on/off indication panel

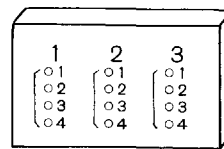

Fig. 3 8 selectable output type indication panel

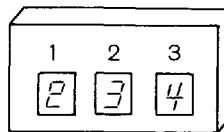

Fig. 4 Decimal output type indication panel

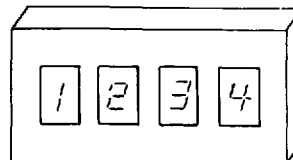
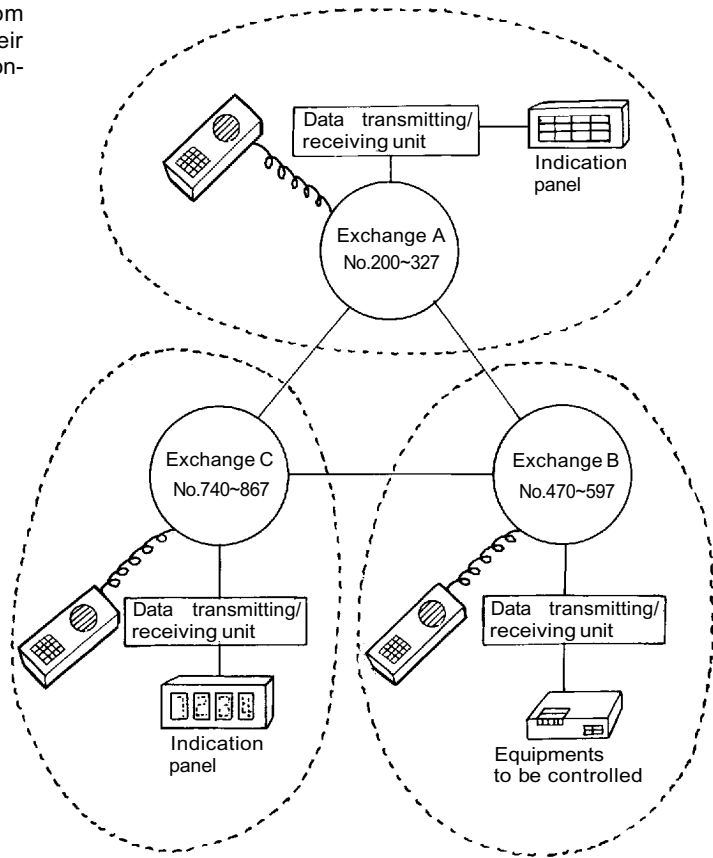

Fig. 5 4 decimal digits type indication panel

Note.

When 2 or 3 exchanges are connected by tie-lines, Data Transmitting and Receiving Units can be operated from the stations which share the same exchange but their operation is impossible from the stations which are connected to the other exchange.



Control of Data Transmitting and Receiving Units of each exchange is only possible from the stations sharing the same exchange and within the same areas circled in dotted lines.

Simplified Paging

If an external speaker is connected instead of a station, simplified paging can be made without the PA amplifier if the caller dials that station number and makes a paging call.

Note.

For further details, please refer to "Installation Handbook for Exchange".

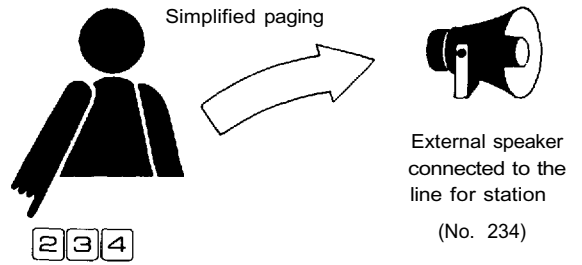

Clear Entry and Conversation Over

1. Clear entry

In the event that an error has been made when dialing for Transfer or Conference, at the start of or during the conversation, dial



This will restore the condition before the error was made, allowing the caller to make a correction without interrupting the call.

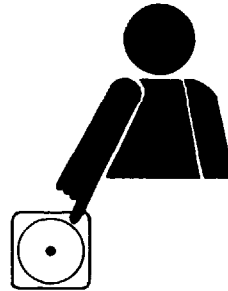

2. Conversation over

To terminate conversation, dial

 or hang up a handset

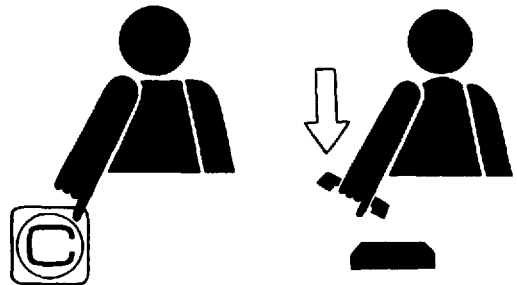



TOA ELECTRIC CO., LTD.
KOBE, JAPAN