



SOUND REPEATER

Full-featured compact performer.

A compact, stand-alone product, the EV-20A Sound Repeater does it all!

And can do it in just about any location.

That's because it incorporates recording, playback, built-in amplifier and speaker, a microphone, sensor and an external input.

Everything that's needed in one package to take care of your broadcasting requirements.



All-in-One

EV-20A

Actual size outline

safe&sound



Easy recording and playback in

Introducing the EV-20A Sound Repeater, a self-contained innovative device that is ideal for high-quality playback and repeating broadcast program content as well as for sensor-activated messages/announcements, BGM and broadcasting in many locations. Its many features, small size and compact dimensions make it especially well suited for unattended use in a variety of applications. The compact dimensions manage to include a built-in amplifier and speaker as well as built-in microphone and external line input to increase its versatility for different applications. Featuring fully digital recording and playback of up to two different messages/announcements and two different music selections with CD-quality audio, the EV-20A also accepts audio files downloaded from a PC via its USB link.

Message / BGM Recording

Built-in Microphone

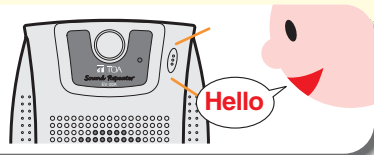

External Microphone

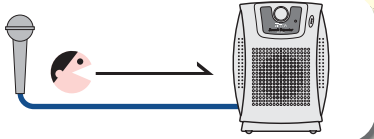

External audio equipment

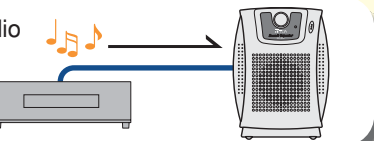

Easy file downloading

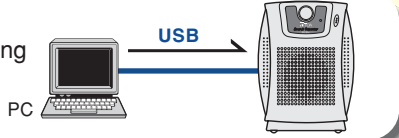

Playback

By Sensor activation



By external activation

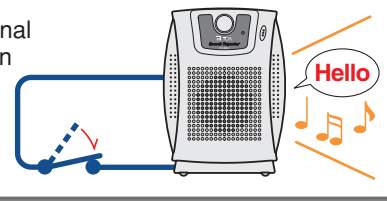

By interval activation

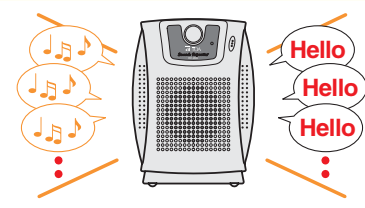

Easy to install anywhere

*Some practical EV-20A application examples are:
Galleries and museums— placed close to an exhibit, the EV-20A provides an automated, unattended explanation of the exhibit.*

Supermarkets and store displays that can benefit from

*sales talk/ product explanations.
Unattended reception counters.*



Use as a convenient integrated amplifier/speaker combination

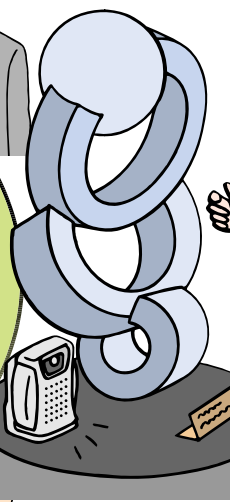
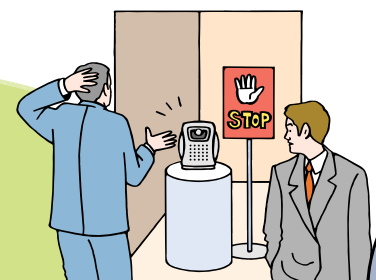

a compact, full-featured unit.

Compact, all-in-one configuration offers many synergistic advantages.





Combining a digital announcer unit with a built-in amplifier, speaker, microphone and sensor results in a powerful yet compact product that handles different applications.

Two messages and two BGM selections can be combined.

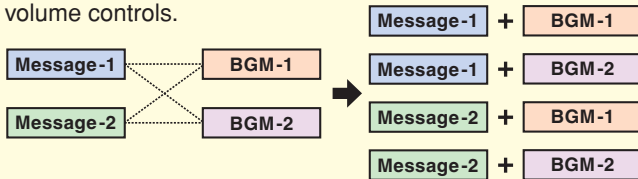
Flexible message and BGM combinations possible with separate message and music selector controls as well as volume controls.

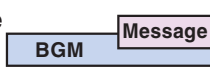

Three playback mixing modes to choose from.

- BGM commences and a message voice over is added. 
- BGM level reduces when message starts. 
- BGM commences and stops before the message starts. 

SmartMedia to create an optimal announcement that can be as long as six minutes.

Program material can be transferred directly from the PC into the inserted SmartMedia card via the USB connector. SmartMedia also makes it easy to store different program material on different cards and simply insert the required card into the EV-20A.



Note: duration of program depends on SmartMedia card storage capacity. Six minutes will require a 32 - 128MB card. *32MB card provided as standard equipment.

Playback versatility

Sensor activation

The built-in sensor activates an announcement that will run its whole length before stopping and waiting for the next activation.

By interval activation

Messages/announcements and music selections can be played back repeatedly at preset intervals.

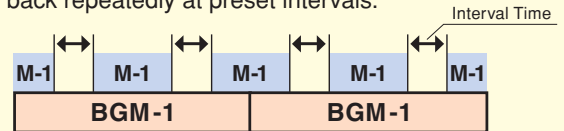

By external activation

External equipment can be used to activate the EV-20A's playback of a selected message by transmitting a pulse exceeding 200ms. In this case the broadcast is one time only and will not be repeated unless the contact is maintained.

Digital high quality sound

Fully digital, the EV-20A maintains the same high level of sound quality that is CD-level over time as there are no moving components to wear out. The EV-20A's frequency response is specifically tailored to enhance announcement audio quality. Announcements can also be punctuated with chimes. Being fully digital reduces mechanisms so the EV-20A is totally reliable.

Useful software CD-ROM accessory

EV-20A software containing a variety of useful files including a library of music files* is provided. System requirements: PC running Windows 2000/XP.

*copyright-free



A highly cost-effective broadcast system can be assembled by configuring up to 16 EV-20A units using USB hubs.

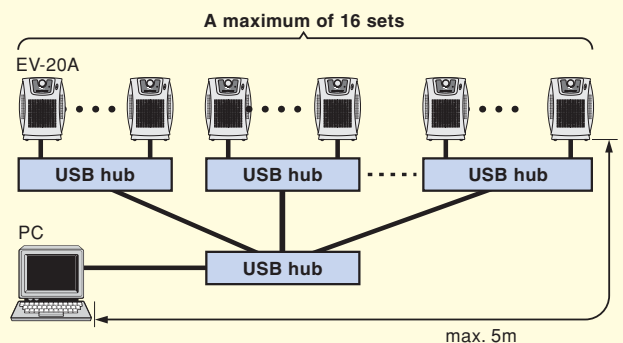

SPECIFICATIONS

* 0dB = 1V

Power Source	AC mains, 50/60Hz (supplied from AC adapter (accessory))
Rated Output	3W
Power Consumption	10W (rated output)
Wave Format	44.1kHz sampling frequency, 16-bit PCM (monaural)
Sensitivity	90dB (3W, 1m)
Frequency Response	200 – 10,000Hz (–10dB)
Distortion	Under 1% (rated output)
Recording System	USB data transfer or analog recording
Control Input	1 input, external activation: 200ms pulse make system, interruption: make/break system. no-voltage make contact input, open voltage: 3.3V DC, short-circuit current : 1mA, removable terminal block (2 pins)
Input	Mic: –40dB*, 2.2kΩ/Line: 0dB*, 10kΩ, (Mic/Line changeable), unbalanced, mini jack Built-in microphone: –44dB*, 2.2kΩ, electret condenser mic.
Sensor	Detection range: Approx. 3.0m Detection speed: Approx. 0.3 – 1.5m/s
LED Indicator	Message, BGM, recording, USB
Operating Section	Slide switch: Message selection, BGM selection, sensor ON/OFF, recording selection, playback mode, power, Mic/Line selectable Rotary switch: Playback interval, equipment identification Push switch: Recording Volume: Message, BGM
Maximum No. of Messages	4 (messages: 2, BGM: 2)
Maximum Recording Time	Approx. 3 min (when 16MB, 3.3V SmartMedia is in use) Approx. 6 min (when 32 – 128MB, 3.3V SmartMedia is in use) (Note: SmartMedia under 8MB or over 256MB and of 5V version cannot be used.)
Playback Interval Time	∞, 0s, 5s, 10s, 30s, 1 min, 5 min, 10 min, 30 min or 1 h (selectable)
Speaker Component	8cm cone-type
Finish	Case : ABS resin, silver
Dimensions	144 (W) × 195 (H) × 101 (D) mm (excluding rubber foot)
Weight	850g
Accessory	SmartMedia (over 32MB) × 1, USB cable (1m) × 1, CD-ROM (USB data transfer software and sample chimes recorded) × 1, Removable terminal plug (2 pins) × 1, AC adapter × 1,
Option	Mounting bracket: C-BC31

USB Data Transfer Software Operation Environment

Personal Computer	IBM-AT compatible type (equipped with the USB terminal)
Main Specifications	CPU: Pentium compatible CPU of 133MHz or more Memory: Over 64MB (recommended: 128MB or more) Free disk space: Over 10MB (space for message storage excluded)
OS	Windows 2000/XP

Notes: Pentium is a trademark of Intel Corporation.
Windows is a trademark of Microsoft Corporation.
Other company names and products are also trademarks of individual companies.

APPEARANCE

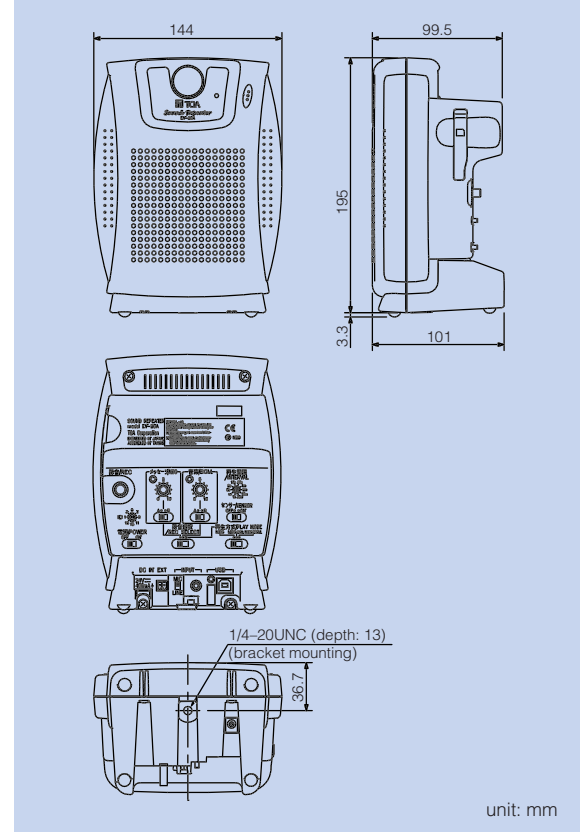

OPTIONAL ACCESSORY

